

RAILWAY®

EQUIPMENT

#7 2018



SPECIAL ISSUE
INNOTRANS
2018

UNION OF INDUSTRIES OF



UIRE Members

- ABB LLC
- Academician N.A. Semikhatov Automatics Research & Production Corporation (NPOA) JSC
- All-Union research and development centre of transport technologies (VNICTT)
- Alstom Transport Rus LLC
- Amsted Rail Company inc
- ASI Engineering Center LLC
- Association of outsourcing agents NP
- Association of railway braking equipment manufacturers and consumers (ASTO)
- AVP Technology LLC
- Azovelectrostal PJSC
- Balakovo Carbon Production LLC
- Baltic Conditioners LLC
- Barnaul Car Repair Plant JSC
- Barnaul plant of asbestos technical products JSC
- Bauman Moscow State Technical University
- Belarusian Railways NU
- Bridge and defectoscopy R&D Institute FSUE
- Cable Alliance Holding LLC
- Cable Technologies Scientific Investment Center CJSC
- Car Repair Company LLC
- Car Repair Company One JSC
- Car Repair Company Two JSC
- Car Repair Company Three JSC
- Car & Wheel Workshop LLC
- Cars R&D Centre JSC
- Car Building R&D Centre JSC
- Center Priority CJSC
- Certification and Licensing Expert Center LLC
- Dialog-Trans LLC
- Dolgoprudny Research & Production Enterprise JSC
- ELARA JSC
- Electro C LLC
- Electro-Petersburg CJSC
- Electromechanics JSC
- Electroprivyamitel JSC
- ELTEZA JSC
- Emperor Alexander I St. Petersburg State Transport University
- Energoservice LLC
- EPK-Brenco Bearing Company LLC
- EPK Holding Company JSC
- EVRAZ Holding LLC
- Expert Center for certification and licensing, LLC
- Eurosib SPb-TS, CJSC
- Faiveley Transport LLC
- Faktoriya LS
- Federal Freight JSC
- FINEX Quality
- Fink Electric LLC
- Flaig+Hommel LLC
- Freight One JSC
- GEISMAR-Rus LLC
- HARP Oskol Bearing plant JSC
- Harting CJSC
- Helios RUS LLC
- Infrastructure and Education Programs Foundation of RUSNANO
- Information Technologies, LLC
- Institute of Natural Monopolies Research (IPEM) ANO
- Interregional Group of Companies INTEHROS CJSC
- Izhevskiy Radiozavod (IRZ) JSC
- JG Group LLC
- Kaluga Plant "Remputmash" JSC
- Kalugaputmash JSC
- Kazakhstan temir zholy RSE
- Kazan National Research Technological University (KNRTU)
- Kriukov Car Building Works PJSC
- Knorr-Bremse Railway Transport Systems
- Holding CIS LLC
- Kupino Car Repair Company LLC
- Machinery and Industrial Group N.V. LLC
- Metallinvestinnovatsia LLC
- "Milorem" Michurinsk Locomotive Repair Plant JSC

RAILWAY EQUIPMENT (UIRE)

- Moscow State University of Railway Engineering (MIIT)
- MTZ TRANSMASH JSC
- MuromEnergomash LLC
- Murom Railway Switch Works JSC MYS CJSC
- Nalchik High-Voltage Equipment Plant JSC
- New Car Repair Company LLC
- NIIAS JSC
- NIIEFA-Energol LLC
- NIPTIEM PJSC
- NPC Springs LLC
- Oktyabr' Product Corporation FSUE
- OrelKompressorMash JV LLC
- Ostrov SKV JSC
- Power Machines – Reostat Plant LLC
- Profit Centre Plus HC LLC
- Radioavionika JSC
- Rail Commission NP
- RailMatik LLC
- RailTransHolding Group LLC
- RDC Informational technologies LLC
- RDC Privod-N CJSC
- “Ritm” Tver Brake Instrument Production JSC
- RM Rail Holding company LLC
- Roslavl Car Repair Plant JSC
- RPE VIGOR LLC
- RPC Dynamics LLC
- RPC INFOTRANS JSC
- RPC United Wagon Company (UWC) PJSC
- RPC Uralvagonzavod JSC
- Russian Railways JSC
- Russian Register Certification Association
- RZD Trading Company JSC
- Samara State University of Railway Engineering (SamGUPS)
- Scientific Instruments JSC
- Schaeffler Russland LLC
- SDS-MASH Holding Company
- SE Plant Electrotyazhmash
- SG-Trans JSC
- Siemens LLC
- Sinara – Transport Machines (STM) JSC
- SKF Tver LLC
- Southern Center for certification and trials, LLC
- SPA RoSAT JSC
- SPA SAUT LLC
- SPC Electromashina JSC
- SPC Dolomant CJSC
- Special Design Turbochargers Bureau (SKBT) JSC
- SPE Smelyansky Electromechanical Plant LLC
- Start Product Corporation FSUE
- Sudotechnologiya Industrial Export Company CJSC
- Teploservice LLC
- Tikhoretsk Machine Construction Plant (TMCP V.V.Vorovsky) JSC
- Tikhvin Car Building Plant (TVSZ) JSC
- Timken-Rus Service Company LLC
- Titran-Express – Tikhvin Assembly Plant JSC
- Togliatti State University
- Tomsk Cable Factory LLC
- TPF RAUT LLC
- TransContainer PJSC
- TransEnergol LLC
- Transmashholding CJSC
- Transmashproekt JSC
- Transpnevmatika JSC
- Transport Equipment Plant CJSC
- TRANSWAGONMASH LLC
- TVEMA CJSC
- Tver Carriage Works (TVZ) JSC
- United Metallurgical Company JSC
- URAL ATI JSC
- Ural Car Repair Company CJSC
- Ural Locomotives LLC
- Urak Transregional Certification Centre NSEI
- Uralchem-Trans LLC
- Uralgroshakhtkomplekt CJSC
- Vagonmash LLC
- VNIIZHT JSC
- VNIKP JSC
- VNIKTI JSC
- VNIIR JSC
- Voith Turbo LLC
- Vyksa Steel Works JSC
- Weidmüller LLC
- Yahting LLC
- Zavod Metallokonstruktsy JSC
- Zheldorremmash JSC
- Zvezda JSC

Published by



Institute of Natural Monopolies Research
2/7 bldg. 1, Malaya Bronnaya Str.,
Moscow, Russia, 125104
Tel.: +7 495 690 1426
Fax: +7 495 697 6111
vestnik@ipem.ru
www.ipem.ru

Supported by



Union of Industries of Railway Equipment
3, Rizhskaya sq., Moscow, Russia, 107996
Tel.: +7 499 262 2773
Fax: +7 499 262 9540
opzt@opzt.ru
www.opzt.ru



**Committee on Railway Engineering
of Russian Engineering Union**

The magazine is registered by the Federal Service
on Mass Media and Cultural Heritage
Protection Control, license PI № FS77-31578 of
25.03.2008

The magazine is included in the Russian
Science Citation Index database.

Printed by City Print Typography LLC
10 bldg. 41, Dokukina st., Moscow, Russia, 129226
Circulation: 1000 copies

Passed for printing: 10.08.2018

All rights reserved. Reproduction
and transmission of the Railway Equipment
Journal materials is allowed only
with reference to the issue.

Not for sale.

Editorial board

Editor-in-Chief

Valentin Gapanovich,
Dr., Senior Adviser to the Director General of Russian Railways JSC, President, UIRE

Deputy Editor-in-Chief

Yuri Saakyan,
*Dr., Director General, Institute
of Natural Monopolies Research,
Vice President, UIRE*

Deputy Editor-in-Chief

Sergey Palkin,
PhD, Prof., Vice President, UIRE

Rushan Alyaudinov,
*Dr., President, Ankor Bank,
Corresponding member
of AENPD Russia, Member of IIA*

Oleg Senkovskiy,
*First Deputy Chief of the Technical
Audit Center, Russian Railways*

Viktor Kureichik,
*PhD, Prof., Member of RANS,
Chairholder, SFedU,
Honoured Science Worker of Russia*

Igor Tomberg,
*PhD, Prof., Head of Energy and
Transport
Research Center of the RAS
Oriental Studies Institute*

Anton Zubikhin,
*Dr., Deputy Director General,
Sinara Transport Machines
Vice President, UIRE*

Roman Savushkin,
*Dr., CEO, United Wagon
Company (UWC)*

Vladimir Matyushin,
Dr., Prof., Vice President, UIRE

Jan Harder,
CEO, Molinari Rail Systems

Anatoly Mescheryakov,
*Vice President, State Secretary,
Russian Railways*

Oleg Trudov,
*Head of division in Technical Policy
Department, Russian Railways*

Bulat Nigmatulin,
*PhD, Prof.,
Chairman of Board of Directors,
Progress-Ecologia*

Alexander Salitsky,
*PhD, Chief Researcher of the
RAS Institute of World Economy
and International Relations*

Yuri Plakitkin,
*PhD, Prof., Member of RANS,
Deputy Director of the RAS
Energy Research Institute*

Alexander Akimov,
*PhD, Head of Economics Research
Department, RAS Oriental Studies
Institute*

Elmar Pozamantir,
*PhD, Prof., Chief Researcher
of the RAS System Analysis Institute*

Stanislav Zhukov,
*PhD, Head of Energy
Research Center,
RAS Institute of World Economy and
International Relations*

Publishing Team

Publishing Editor:

Elizaveta Matveeva

Translator:

Margarita Stupina

Editor:

Kevin Smith
Sergey Belov

Designer:

Olga Poskonina



32 | Russian rolling stock sector: time to invest



73 | Russian Railways at 15: state railway leads manufacturing development



20 | Digital Railway: from Concept to Reality

Contents

 EDITORIAL 	4	 STATISTICS 	38
 OPINION 		 ENGINEERING DEVELOPMENT 	
<i>Anna Orlova.</i> Changing market demands concept for «smart wagon»	6	<i>Alexander Gulyaev, Arkady Zaytsev.</i> ‘Moskva’ Metro Train	42
<i>Alexander Polikarpov.</i> Russian rolling stock becomes increasingly attractive in international markets.	8	<i>Leonid Gurevitch, Victor Fokin.</i> Compact messenger cable solutions for high-speed rail lines	50
 MAJOR EVENTS 		<i>Igor Lakin, Vitaly Pavlov, Victor Melnikov.</i> How can machine learning and BigData benefit locomotive transmission diagnostics?	54
Rail solutions for FIFA World Cup	10	<i>Oleg Gur’yashkin.</i> Efficient applications of rechargeable Li-Ion Batteries	62
 TRENDS 		<i>Sergey Chuev, Nikita Borisov, Sergey Timkov.</i> A practical application of RAMS studies for brake systems	66
<i>Jan Harder.</i> Global rail industry continues to consolidate	14	 ANNIVERSARY 	
<i>Efim Rozenberg.</i> Digital Railway: from Concept to Reality	20	Russian Railways at 15: state railway leads manufacturing development	73
<i>Ilya Tereshko.</i> Regulatory changes seek to encourage third-party investment in passenger rail.	25	 EVENTS 	
<i>Michele Molinari, Jan Harder.</i> What role can CNG and LNG play in railway transport?	28	UIRE – bringing together Russia railway manufacturers	76
 ANALYTICS 			
<i>Igor Skok.</i> Russian rolling stock sector: time to invest	32		

Dear Readers and Guests of InnoTrans 2018,

It is my great pleasure to present and introduce this special edition of Railway Equipment Journal. The issue includes articles written by leading Russian and international railway experts and covers some of the key current railway industry trends, including the digital transformation of rolling stock manufacturing and operations, and the introduction of alternative energy sources like natural gas and Li-ion batteries. You will also find articles on the processes and technologies used to deliver successful railway passenger services during the FIFA World Cup and the development of state-of-the-art trains for Moscow Metro.

Today, the Russian railway industry is on the verge of making significant breakthroughs in performance thanks to the deployment of digital technologies. The process began during preparations for the XXII Sochi Winter Olympic Games held in Sochi with a very ambitious and successfully implemented automation project for passenger services. This experience informed the subsequent introduction of a time-interval service on the Moscow Central Circle (MCC), a brand-new railway, which opened in 2016 and has since proved popular among capital city residents with more than 200 million passengers already using the service. Other major projects such as driverless shunting operations at Luzhskaya marshalling yard have also been introduced during this period while new IT projects continue to evolve. Russian Railways is currently undertaking a network-wide 'Digital Railway' automation project, which is set to shape the image of railway transport for decades to come. A description of this concept is found can be this issue.

The Russian rolling stock manufacturing sector is also undergoing significant changes. Concerted efforts to meet IRIS and ISO certification standards at manufacturing facilities in recent years has not only resulted in upgrades to production processes so they are at the same level as the leading international companies, but has also created the foundation for further automation and the introduction of the Internet of Things. Current international economic conditions and the Russian government's transport infrastructure



development and digital transformation policies indicate that rolling stock production will be among the fastest developing sectors of Russia's machine building industry. Within this environment, the Railway Equipment Industries Union (UIRE) is playing an important role as a leading coordinator and place for open analysis of the industry's performance. Since it was founded in 2007, UIRE has become a hub for high-level discussion among experts dealing with industrial engineering innovations and processes at existing and new market players. Here these individuals are able to think beyond their own companies to embrace the bigger picture and develop a single technical policy, which is shared by the entire industrial community.

We are always open to sharing new ideas and experiences, and with this issue of our magazine we offer our sincere invitation to all interested companies and community representatives to join the dialogue. Welcome to the future that is already here!

Sincerely yours,
Valentin Gapanovich
 Editor-in-Chief of Railway Equipment Journal
 President of UIRE,
 Senior Adviser to the Director General
 of Russian Railways

Transmashholding
#1 manufacturer
in Russia and CIS



With an extensive product portfolio and engineering capabilities, Transmashholding offers **future-proof transportation solutions:**

- Locomotives
- Passenger and Freight Trains
- Urban Trains
- Services and Components

Presence on global markets is backed by Transmashholding's 100% subsidiary TMH International through **co-investment, localization, partnerships, and technology sharing.**

VISIT US AT INNOTRANS 2018
MESSE BERLIN, HALL 3.2A
BOOTH 405

InnoTrans



Changing market demands concept for «smart wagon»



Anna Orlova
PhD, Deputy
CEO of
Scientific and
Technical
Development
at United
Wagon
Company
(UWC)

United Wagon Company has the capability and experience of conducting the full cycle of work with railway freight wagons: from design and production to operation, maintenance and repair. As we look to develop the next generation of freight rolling stock, we are closely examining growing international experience with the application of various digital technologies in wagon manufacturing – technologies which we believe can minimise or entirely eliminate the human factor in decision-making which can improve the openness of information available on asset condition and ultimately traffic safety.

It is still unclear what electronic systems should be installed on a freight wagon or introduced on infrastructure to optimise the economics of freight transportation for wagon owners and operators. Therefore, it is important we answer the question: what exactly do we want from a «smart wagon?»¹ Conceptually, we see four tasks that an electronic system can solve.

The first is the continuous monitoring of the condition of a freight wagon while in operation. For example, are there any defects on the rolling surface of the wheels? Is the spring suspension normal, or is the car overloaded? This is nothing new and various scientific organizations are trying to present viable solutions both in our country and abroad. Ultimately this process promises to enable repairs to be conducted according to the state of a wagon while increasing the detection of hidden faults and reducing the vehicle's impact on the track thanks to the timely detection of defects on the rolling surface of the wheels.

The second task, which the infrastructure owner may be interested in solving, is the ability to monitor the technical condition of the track by taking measurements directly from freight wagons as they pass over specific infrastructure points. This involves registering dynamic indicators, studying the interaction of the car with the railway track, and identifying priority areas for repair.

The next task for the smart wagon system is to monitor compliance with operating conditions. This implies the identification of inconsistencies with the standards for wagon operation. For example, damage may be caused when a wagon descends a hump with excessive speed, when too much force acts upon the coupler, or from problems with a grapple truck's loader during unloading. All of these events can be monitored. However, there is a conflict of interest when solving such a task. On the one hand, the owner of the rolling stock is interested in the careful use of their wagons. On the other hand, rolling stock operators are not always interested in disclosing the events, times and precise locations of where freight wagons have been misused.

Finally, the fourth task and opportunity provided by the smart wagon system is monitoring resource expenditure. This involves the continuous observation of the operation and dynamic load of an individual wagon from which it is possible to determine whether its has reached the end of its usable life.

According to our estimates, when creating the smart wagon concept, the transition from scientific research to practice can take about three years due to the amount of time it takes to launch pilot projects. But why does it take so long?

First, unlike a passenger coach or a self-propelled rail vehicle, a freight wagon has no reliable source of energy. As a result, any electronic system that we would like to design and incorporate into a «smart wagon» is tied to the development of a reliable source of energy.

Second, it is necessary to solve the difficult technical task of organizing the collection and processing of information, since the methods and measuring equipment used to test rolling stock does not address the issue of energy efficiency. Strain gauges are mostly used when measuring performance and the effects of different operating parameters on a wagon during tests, and they consume a huge amount of the electricity available to a freight wagon.

¹ The term «smart wagon» refers to an intelligent control system installed on a freight car which collects, processes, and exchanges information with remote data storage systems.

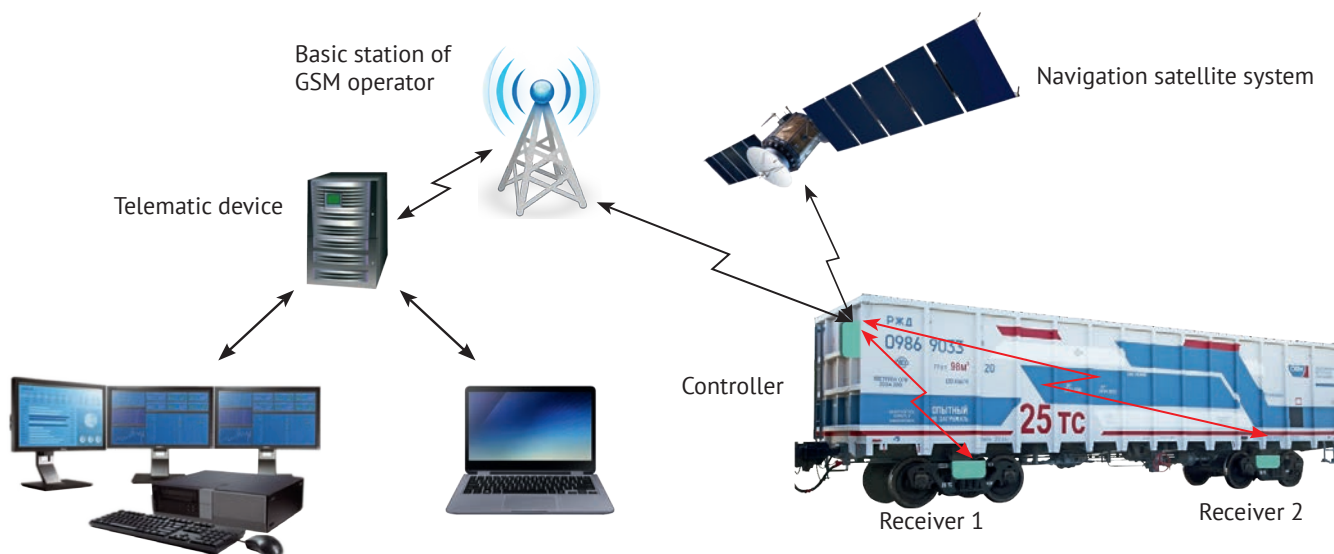

The scheme of information exchange system

The development of a system of sensors, amplifiers, converters, and processing controllers that collect all of the information while taking into account any available electric power and power consumption is a serious task that has not yet been solved and runs counter to the effective regulatory documents for wagon testing.

In addition, there is a problem with the identification of events. So far, when testing new rolling stock, we set ourselves the task of determining whether the wagon is fit to withstand the impact of operation as specified by regulatory requirements. But in a «smart wagon» it is necessary to take continuous measurements throughout the process of operation and identify which operating scenario they comply with on this basis. For example, if the wagon was damaged while it descended a hump or by a grapple truck's loader, it is necessary to distinguish between these events by analyzing the measurements taken from the wagon. Identifying which event was caused by analyzing a combination of measurement indicators is an unsolved scientific task that must be overcome.

A Big Data control system is the general term used for the final large superstructure where the data obtained from the onboard wagon measurement system is stored and processed. Of course, it is possible to identify and develop a variety of these types of systems. However, it is important for a Big Data control center to be unified and work accord-

ing to a uniform protocol. In its research and development program, the Association Vagonostroiteley Partnership (the Railcar Producers' Association) is currently engaged in the task of creating a unified telemetry system that would effectively manage all the information collected from onboard diagnostics sensors.

In a few countries, some elements of the «smart wagon» have already been applied. At an Australian railway, for example, a system has been introduced in which solar panels are installed on freight wagon to provide the energy source for sensors which monitor the condition of the railway. This system can provide a warning to the appropriate units when it is time to repair a specific track section and is viable as there is virtually unlimited access to solar power. There are also examples of operating systems that detect wheel defects, including in the United States. Accelerometers, an amplifier and a block that processes the measured accelerations and detects flat spots and dents have been installed on wheelset adapters and are proving effective. Similarly, in Europe, systems are in use to monitor certain events relating to freight wagon operation such as shocks during transportation which is helping to inform maintenance practices.

In light of these examples and strong progress in this area, participants in the Russian rail freight market need to determine which of the possibilities of developing a truly «smart wagon» will be most in demand and applicable to Russian operating conditions. ☺

Russian rolling stock becomes increasingly attractive in international markets



Alexander Polikarpov
Deputy Head of the Railway Research Department
at Institute of Natural Monopolies Research (IPEM)

Russian rolling stock manufacturing has made significant progress in entering off-shore markets in recent years. The potential for the export of rolling stock export is reliant on four major factors: the availability of a competitive product, cheap money, well-organized maintenance and a successful track record of delivering projects.

At the end of the 20th and in the early years of the 21st century, Russian-built railway vehicles were exported mainly to neighbouring CIS countries and the states of the former Soviet bloc. The collapse of the USSR led to a breakdown of many of the established supply chains and partnerships for some key products, including the manufacturing of main line diesel locomotives in Ukraine. The gradual transition of the Russian economy from a state-driven to market-based system further aggravated this

situation, leading to dramatic fall in orders, a reduction in R&D investment, and a loss of a long-term vision for the sector.

In the mid-2000s, Russian Railways (RZD), a successor to the Russian Ministry of Communication Lines, set Russia's rolling stock manufacturers ambitious targets to create new rolling stock products, which would answer the requirements of the time. At the state level, the new focus on sector modernization was enshrined in 2007 through the Transport Engineering Development Strategy adopted by Russia's Ministry of Industry and Energy.

An important trend of the time was the decision by local manufacturers to harness international experience and imported solutions by establishing joint ventures with key international players in order to transfer technology by localising production. This policy made considerable progress in just a few years with the development of several new locomotives for the 1520mm-gauge market, notably the diesel 2TE25K, and electric 2ES10 & EP20 locomotives, as well as various EMUs, metro rolling stock and freight wagons. The technical features of these new products are in line with international trends and standards and are suitable for export to global markets.

While Russia's export support framework dates back to the 1990s, active and systematic export support from the government for the country's engineering sector began



Shipping of Sinara TGM8km shunting locomotives to Cuba.

in 2015 with the establishment of the Russian Export Center (REC), a body intended to integrate and drive export promotion initiatives and activities for manufactured goods. In late 2016, the government, enacted the 'International Cooperation and Export Project' which identified rolling stock manufacturing as one of its key focus area. Various financial support packages were made available to Russian manufacturers including export financing, assurance provision, and insurance packages, which were so extensive that they enabled Russian manufacturers to offer more attractive financial terms to prospective clients than the vast majority of global manufacturers, perhaps with the exception of Chinese firms. At the same time, REC and manufacturers continue their efforts to increase the attractiveness of Russian financing.

One of the key trends in the Russian market in recent years is the development of maintenance business units by the leading rolling stock manufacturers. Transmashholding and Sinara Group established their locomotive maintenance divisions in 2010, and both are currently providing maintenance services for RZD's locomotive fleet. Maintenance contracts have also been adopted as part of procurement contracts for metro vehicles and DMUs.

The change in approach to maintenance contracting has shifted operator's expectations to go beyond simple training programs for in-house maintenance workforce to embrace the deployment of a full-scale after-sales service network by the chosen manufacturer. Development of such a service chain network inevitably means the implementation of online monitoring and remote diagnostics systems as well as on-time delivery of spare parts, 24-7 support, in-field emergency repairs, and a flexible approach to the client's needs. The further development of maintenance services is cited as a key priority in the Rolling Stock Export Development Strategy endorsed by the government in 2017.

Russian manufacturers are already establishing international service infrastructure networks which are searching for possible opportunities to deliver rolling stock and



Metro cars for Budapest after major repair by Transmashholding

provide services to overseas clients. For example, the Argentinian subsidiary of Transmashholding secured a contract this April to maintain locomotives originally supplied by a Chinese manufacturer. This is the company's first Argentinean contract, and in my opinion, the manufacturer is going to use this opportunity to establish itself as a reliable supplier. Transmashholding's success follows the award of a contract to Sinara Group in Cuba in 2017 for the maintenance of a legacy locomotive fleet and the supply of 75 new shunting locomotives by Cuba.

With the business world shifting towards turnkey projects that integrate infrastructure construction, rolling stock deliveries and aftersale maintenance of the transport system, the expectations of international customers are growing every year. These large-scale projects often have strong political connotations, which reach beyond the influence of market players. Nevertheless, technological advancement, attractive financial terms, experience from delivering existing supply and maintenance projects, and a willingness to offer all-in solutions including rolling stock and infrastructure are increasing the attractiveness of rail vehicles built in Russia for rail operators and authorities around the world. 🇷🇺

Rail solutions for FIFA World Cup

In 2010, Russia was awarded the rights to stage the 2018 FIFA World Cup. Preparations started immediately. Eleven cities – Moscow, Kaliningrad, St Petersburg, Nizhny Novgorod, Volgograd, Kazan, Samara, Saransk, Rostov-on-Don, Sochi, and Yekaterinburg (see pic. 1 and Table 1) – hosted fans and guests from around the world during the 21st World Cup, which ran from June 14 to July 15. Providing comfortable and convenient travel between the host cities was one of the most challenging and ambitious objectives for the tournament’s organisation team. Railway transport played a significant role in achieving this and successfully transported more than 5 million football fans and visitors between host cities during the tournament.





Railway transport’s role in Russian passenger traffic

Railways are the primary means of passenger transport in Russia, with rail traffic accounting for 22% of overall domestic ridership in 2017. As one of the largest networks in the world, Russia’s railway system provides connections between not only big cities but also medium and small towns throughout the country’s vast territory, which extends for

about 4,000km from north to south and more than 10,000km from west to east. A feature of many rail journeys in Russia is that they last for days, with sleeper trains employed on long-distance routes. A rail journey is therefore much more than just a common trip from point A to point B, it is an integral and traditional element of Russian culture.



Pic. 1. Distances between Moscow and the other host cities

Type of trains	Single-deck long distance	Double-deck long distance	Single-deck Lastochka EMUs	Single-deck Strizh railcars
Number of trains	53	18	2	2
Respective number of railcars 	848	268	20	40
Dining cars 	Single-deck dining car	Double-deck dining car	No dining cars in Lastochka trains	A club car and dining car per Strizh trainset
Railcar average age 	7 years	2 years	3 years	3 years
Availability of WiFi, HVAC and eco-safe WC 	✓	✓	✓	✓
Wheelchair passenger services 	✓	✓	✓	✓

Note: Special free rail transport services using Sapsan high-speed trains were also available for the mass media on the Moscow – St Petersburg – Moscow route during the World Cup

Fig. 1. Free rail services provided to 2018 FIFA World Cup visitors

World Cup rail terminals

Renovations of 33 rail terminals in host cities and five rail terminals at intermediate stops on the network were carried out ahead of the World Cup to provide comfortable services for the tournament’s fans and visitors. Work by Russian Railways (RZD) included station modernisation, with an emphasis on enhancing security and adapting facilities for use by disabled passengers. Total investment in these projects amounted to Roubles 116.9m.

Specific work comprised the construction and deployment of smart terminal infrastructure, including the use of automated traffic control centres. These centres provided round-the-clock control and monitoring of major utility systems including ventilation, air conditioning, lighting, heating, and air humidifying systems, which became especially important on busy match days.



Livestream of FIFA World cup match in Moscow subway train

Table 1. Distance between 2018 World Cup host cities and average travel time by car, train and air

City	Moscow		Kaliningrad		St. Petersburg		Kazan		Nizhny Novgorod	
Ekaterinburg	1,804	22h 25min	3,140	46h 50min	2,483	35h 55min	1,024	14h 45min	1,394	19h 19min
	25h 00min	2h 10min	45h 00min	3h 30min	34h 00min	2h 30min	12h 50min	1h 35min	19h 00min	1h 55min
Sochi	1,634	24h 49min	2,715	50h 24min	2,327	38h 17min	2,046	34h 07min	2,018	33h 29min
	22h 00min	2h 10min	41h 30min	3h 20min	31h 20min	2h 55min	31h 30min	2h 30min	31h 05min	2h 25min
Rostov-on-Don	1,037	16h 34min	2,220	41h 17min	1,730	28h 56min	1,449	24h 25min	1,421	24h 07min
	13h 10min	1h 35min	33h 20min	2h 50min	22h 40min	2h 25min	22h 50min	2h 05min	22h 20min	1h 55min
Volgograd	940	16h 51min	2,250	40h 16min	1,633	27h 59min	975	16h 18min	947	16h 43min
	13h 20min	1h 35min	33h 20min	2h 55min	22h 20min	2h 20min	14h 50min	1h 40min	13h 50min	1h 30min
Saransk	627	10h 34min	1,951	31h 59min	1,317	22h 22min	406	6h 46min	255	4h 18min
	8h 10min	1h 20min	27h 50min	2h 40min	17h 20min	2h 10min	6h 10min	1h 10min	3h 40min	0h 40min
Samara	1,030	14h 45min	2,355	43h 46min	1,720	29h 51min	481	8h 07min	760	12h 44min
	15h 20min	1h 30min	35h 10min	2h 45min	24h 20min	2h 15min	7h 00min	0h 55min	11h 40min	1h 05min
Nizhny Novgorod	390	5h 17min	1,725	26h 42min	1,070	14h 56min	370	7h 00min		
	5h 10min	0h 50min	25h 00min	2h 15min	14h 00min	1h 45min	5h 30min	0h 50min		
Kazan	780	11h 21min	2,115	33h 45min	1,460	21h 27min				
	11h 20min	1h 35min	31h 10min	2h 45min	20h 20min	2h 05min				
St. Petersburg	645	3h 45min	970	20h 18min						
	7h 50min	1h 20min	15h 30min	1h 40min						
Kaliningrad	1,280	21h 25min								
	19h 20min	1h 45min								

Passenger service organization

A major initiative to enhance ticket-holders' experience during the FIFA World Cup was the introduction of a special Fan ID, which provided various benefits including free train transfers. The offer of free train journeys has

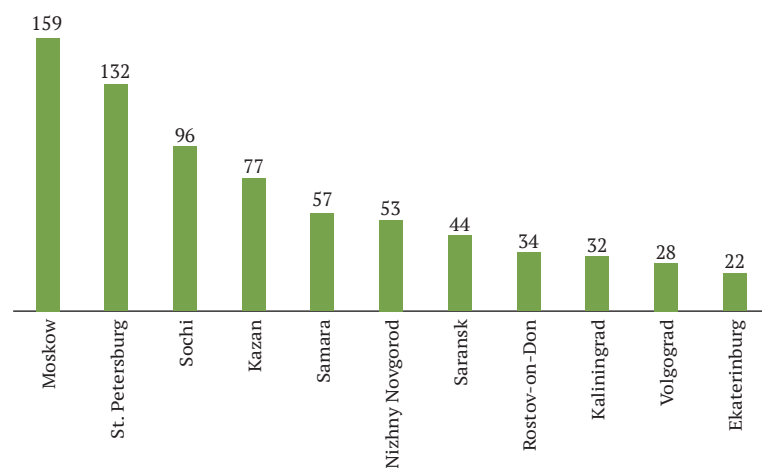

Fig. 2. Number of train assignments into hosting cities

never been provided before at a global tournament with visitors able to book their place on the services a few days before and after a match. More than 2,300 conductors and train managers as well as around 4,000 station employees received training ahead of the tournament, including on the football culture, travel rules and boarding technology of passengers from each of the 32 countries involved.

In total, 75 trains consisting of 1,176 coaches were used to offer free journeys to football fans throughout the tournament. The modern coaches utilised facilities to make the journey as comfortable as possible, including air-conditioning, charging ports, and facilities for wheelchair passengers. Another benefit was a free Wi-Fi service, which supported 425,000 connections and recorded 40 terabytes of traffic consumption during the month-long tournament (fig. 1).

City	Samara		Saransk		Volgograd		Rostov-on-Don		Sochi	
Ekaterinburg	1,026	16h 33min	1,430	23h 27min	1,819	29h 59min	2,293	39h 10min	2,890	46h 54min
	13h 00min	1h 30min	19h 30min	2h 05min	26h 20min	2h 15min	34h 00min	2h 35min	42h 10min	3h 00min
Sochi	1,888	31h 31min	1,791	30h 22min	1,001	16h 32min	570	8h 00min		
	28h 40min	2h 20min	25h 50min	2h 10min	15h 50min	1h 40min	8h 10min	1h 05min		
Rostov-on-Don	1,291	21h 57min	1,129	18h 38min	474	8h 18min				
	20h 30min	1h 45min	17h 20min	1h 45min	7h 00min	1h 00min				
Volgograd	817	13h 13min	720	11h 49min						
	12h 50min	1h 20min	9h 20min	1h 20min						
Saransk	550	09h 03min								
	7h 10min	1h 15min								

Legend

Distance by car	Travel time by car
Travel time by train	Travel time by air

The peak day for travel was June 24 when 45 free trains carried more than 26,000 passengers. A total of 734 free long-distance trains were available during the tournament (fig. 2), with single-deck sleeper trains providing 491 of these trips, double-deck sleeper trains responsible for 217, Lastochka Desiro RUS EMUs offering 16 trips, Sapsan Velaro RUS high-speed trains six

trips, and Strizh Talgo 250 coaches hauled by EP20 locomotives providing four trips. In total, these trains carried just less than 319,000 passengers throughout the tournament.

There were also free journeys on suburban networks for football fans travelling between airports and city centres. These trains carried a further 291,000 passengers.

World Cup summary

More than 5.2 million people travelled between the World Cup host cities during the tournament, with the free trains accounting for 12% of this traffic. Unsurprisingly Russian fans were the largest group to use the free train services followed by visitors from Argentina, Columbia and Mexico, with 15,228, 14,990 and 11,365 respective passengers from each country transported during the tournament. The experience gained during this extensive event has already sparked new ways of working in Russian railway transport, and helped to take station operations and passenger services in particular to a new level. As InnoTrans 2018 rolls around, two months have passed since the close of the 2018 FIFA World Cup. However, a detailed system analysis of rail transport’s performance during the tournament is continuing. 



Brasil supporters at Roston-on-Don railway station

Global rail industry continues to consolidate



Jan Harder
CEO at Molinari Rail Systems

The global rail market has undergone an extensive consolidation process in recent decades. As well as mergers and takeovers, strategic cooperative agreements and alliances between competing manufacturers have taken place. This consolidation is occurring in a very healthy global market environment. Between 2015 and 2025, urban rail transport is the fastest growing market segment and is expected to continue grow with a current compound annual growth rate (CAGR) of 5.2%. Passenger rail transport is also expected to report a 3.2% CAGR and freight rail transport 1.4% CAGR by 2025.¹

World market overview

The positive market outlook for the rail industry and the increasing need for sustainable transport are encouraging trends for the sector's suppliers and manufacturers. Existing capacity for producing and assembling rolling stock must be able to respond to market demand and increasing demand for rail transport in the future. However, at the same time other aspects such as price, localisation and proximity are challenging suppliers around the world. Today's major suppliers already have a global network of engineering and manufacturing sites. However, large development programmes outside of traditional markets are challenging the status and relevance of the supplier's traditional manufacturing locations. For example, you may see Ural Locomotives establish EMU manufacturing facilities in new areas, while Alstom has already set up a new manufacturing facility in South Africa to construct EMUs as part of its work in the Gibela consortium. Similarly, in India both Alstom and GE have recently established new locomotive factories. These sites demand that technology is transferred and that a level of local expertise is established. Investment is therefore only justifiable if further projects are secured beyond the current order duration. However, this situation creates competition for capacity, costs and continuous workload

within these manufacturers. Many European suppliers have already undergone this transformation processes by establishing manufacturing sites in the lower cost regions of Eastern Europe to optimize their overall cost situation as well as combat growing competition in all areas of rolling stock and rail technology, but particularly from China.

Over the last decade several major mergers have taken place in the global rail industry, changing the competitive landscape and also creating new players in the market. This is a trend not only among train manufacturers but also between subsystem suppliers such as Wabtec and Knorr. The main strategic rationale for mergers is to improve financial performance or reduce risk. Specifically, management and shareholders are often driven by the following aspects when considering a merger or acquisition: economy of scale, economy of scope, increased revenue or market share, cross-selling, taxation, geographical or other diversification and resource transfer. Table 1 shows some of the major mergers and acquisitions, which have occurred in the last four decades and have had a significant impact on the market and consolidation of the rail industry.

Two growing players in the rail industry market stand out in this table: Knorr Bremse and Stadler Rail.

¹ See SCI Verkehr Multiclient study «RAIL TRANSPORT MARKETS – GLOBAL MARKET TRENDS 2016-2025»

Table 1. Integration processes of companies from 1985 to 2018*

Year	Acquirer	Target
1985	Heinz Herrmann Thiele	Knorr Bremse
1989	Peter Spuhler	Stadler Fahrzeuge AG
1995	Bombardier Transportation	Deutsche Waggonbau
1997	Stadler Rail Group	Schindler Wagon
2001	Bombardier Transportation	ADtranz
	Stadler Rail Group	Stadler Pankow GmbH
2005	Stadler Rail Group	Winpro AG
2012	Siemens	Invensys Rail
2014	Heinz Herrmann Thiele	Vossloh AG
	CRRC	CNR and CSR
	Alstom	GE Signalling
2015	Hitachi	Ansaldo STS & AnsaldoBreda
	Stadler Rail AG	Vossloh Locomotives Spain
	Knorr Bremse	Selectron Systems
2016	Wabtec	Faiveley
	Knorr Bremse AG	Vossloh Kiepe
	The Greenbrier Companies	ASTRA Rail Management
2017	Knorr Bremse AG	Haldex
	Alstom	Siemens
	Alstom	EKZ Kazachstan (75%)
2017/18	PPF	Škoda Transportation
2018	Transmashholding	Locotech
	WABTEC	GE Transportation

* Rail Consolidation studies, Molinari Rail Group, May 2018

Since 1993, Knorr Bremse has engaged in a concentration and expansion strategy unique in the railway industry. The company has acquired and integrated manufactures of products such as train doors (IFE), air-conditioning systems (Merak), station platform screen doors (Westinghouse), electro-mechanical and electronic components and systems (Microelettrica Scientifica), and train driving simulators (Sydac). The latest acquisition of Vossloh Kiepe forms part of Knorr-Bremse's long-term strategy to expand its business beyond its original core activity of manufacturing braking systems.

Stadler Rail is also worth mentioning as through acquisitions and the formation of joint ventures in Switzerland, Spain, Poland and Germany it has established a complete rolling stock manufacturing and maintenance portfolio. Stadler's international manufacturing sites in Eastern Europe are optimizing the company's cost position in the market, which

is important due to the strong Swiss franc and the high costs of labour in Switzerland.

On April 3 the European Commission (EC) approved the acquisition by PPF Group of Skoda Transportation and its subsidiaries.² The EC examined the transaction under its amplified merger review procedure and concluded that the proposed deal would raise no competition concerns given the negligible overlaps between the companies' activities in the European Economic Area. As well as Škoda Transportation, the PPF Group of the Netherlands, owned by Czech entrepreneur Mr Petr Kellner, acquired Skoda's subsidiary companies Czech-based VÚKV, Škoda Investment and Bammer Trade. In Finland, PPC will be acquired by Jokiaura Kakkonen and Cyprus's Satacoto holding company. Škoda Transportation is engaged in the production, development, assembly, reconstruction, and repair of railway and metro vehicles, trams, trolleybuses and electric bus-

² See IRJ «European Commission approves Škoda Transportation sale», <https://www.railjournal.com/index.php/financial/european-commission-approves-skoda-transportation-sale.html?channel=522>

es, and related services. VÚKV is active in the development, research, and testing of rail vehicles and their parts, as well as related services. Skoda Investment is involved in the renting of property and the granting of licences for the Skoda trademark and is also active, via its subsidiaries, in photovoltaic power generation, IT, and telecommunications technology. Bammer Trade is involved in the repair of public transport vehicles. JK is engaged in the renting of production facilities. Cyprus-based Satacoto is a holding company which is active in the production of electric motors and generators, and the renting of property. PPF is a finance and investment group focusing on financial services, consumer finance, telecommunications, biotechnologies, retail services, real estate and agriculture.

Amidst the turmoil surrounding the required restructuring of General Electric, it was announced in November 2017 that the company was looking to sell its Transportation business in order to optimise its portfolio. Wabtec subsequently confirmed that it had reached an \$11bn deal in May, which is set to propel the second-tier supplier, which is still working on integrating Faiveley following a \$1.7bn takeover in November 2016, into a leading locomotive manufacturer. When it is confirmed, the deal could prove a significant strategic step against Wabtec's primary's competitor, Knorr Bremse. In particular, GE Transportation's installed base of GE locomotives around the world have the potential to serve Wabtec's service and components businesses today and in the future.

Merger of Alstom and Siemens

With traditional manufacturing sites in Europe and an excellent order backlog from European and global customers, Siemens and Alstom announced in September 2017 their intention to merge the two companies into a single organization. The merger will create the second biggest train and rail technology manufacturer in the world and enable the company to more effectively compete with China's CRRC.

The merger has been dubbed as "Railbus" following European aircraft manufacturer Airbus. Both companies possess a strong financial profile which will create the second largest global manufacturer. However, just as importantly, they will combine their respective innovation power. Table 2 show the figures presented by the CEOs of both com-

panies during the merger announcement in September 2017.

The deal, which is expected to close in early 2019, will combine Alstom and Siemens' railway businesses in more than 60 countries and will create a company with 62,300 employees – 32,800 Alstom and 29,500 Siemens. More than 40,000 of these employees will be located in Europe. However the regional presence and market share in the Americas (7,700 employees combined), Middle East/Africa (3,700 employees combined) and Asia (7,500 employees combined) will be strengthened following the combination of manufacturing sites and maintenance operations in these regions.

The merger combines two highly-reowned brands with complimentary portfo-

Table 2. The new Siemens Alstom company in figures

All values in billions EUR	Alstom S.A.	Siemens Rail Systems and Traction Drives from I DT
Backlog	34.8	26.4
Order intake	10.0	8.0
Sales	7.3	8.0
Adjusted EBIT margin	0.4 (5.8%)	0.8 (10.1%)
Net (debt) cash	-0.2	N.A.
Notes:	FY ending March 17	FY ending September 16

Source: Alstom presentation "Creation of a global leader in Mobility," 27.09.2017

lios in four business areas: rolling stock, signalling, services and systems. In the rolling stock area especially Siemens successful locomotive platform Vectron and the tramway business is a perfect add on to Alstom's offer. The addition of Siemens' automated people mover technologies and passenger coaches, which are manufactured in Vienna, will also help Alstom to close the gap on its rival, Bombardier.

On the signalling side Alstom is adding Siemens' intelligent and intermodal traffic systems including road management as well as trackside products, all of which will strengthen the new company's digitalisation offer. The company's maintenance digitalisation and data analytics and asset performance management offering is also enhanced. In the systems business area both companies are joining their experiences with Siemens set to provide in its electrification and turnkey project management expertise. Siemens' e-Highway solutions will also expand Alstom's offer beyond the railway sector towards intermodal mobility. For example, APTIS, a new 100%-electric mobility solution, which offers all the advantages of the tram in a bus, could be a major product for the merged company

Alstom and Siemens' management are preparing to start seeking anti-trust approval relevant authorities for the planned deal, which due to the macro-economic and political dynamic involved, is widely expected to go through. The battleground will be in the "fine print" of the new company. In light of the future threat in the European market from CRRC, the European Union competition watchdog is likely to be lenient, but will still require Siemens and Alstom to offer certain remedies, such as asset sales, to alleviate some antitrust issues. The company's biggest customers are governments and state-owned rail operators, mostly in Europe. They both make high-speed trains that are in cross-border operations in addition to metro, light rail and regional railway vehicles. With combined sales of Euros 15bn, the merged company will remain behind CRRC, but will out rank German-based Bombardier Transportation.

In Figure 1 below the ranking of the new company is shown with reference to comparable global rail companies.

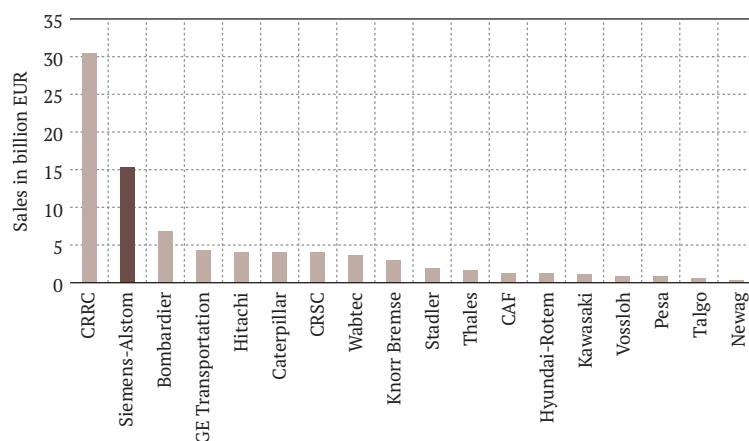

Fig. 1. Position of Siemens-Alstom in the global rail market

The companies signed a business combination on March 23, which sets out the terms and conditions agreed by the two parties for the combination, triggering the start of a formal antitrust process. However, the plan to close the deal by the end of 2018 is likely to be pushed back to the first half of 2019 due to the time needed to prepare for regulatory approval from competition authorities in several countries.

Questions remain over whether when considering the deal, the European Union's competition authority will focus solely on the European regional market, where CRRC has only a marginal presence so far, or consider the global rail-equipment market. Last year, CRRC signed a deal to supply three electric trains to Czech open-access operator Leo Express, its first contract in an EU member country, two years after signing a similar deal with Macedonia. CRRC has also supplied electric locomotives to Serbia. While the Chinese company is planning further expansion in Europe in the next few years, it currently only receives eight percent of total sales from outside of China. However, the size of CRRC is a concern to European players, with the Chinese company four-times bigger than Alstom alone. CRRC's rise follows the decision by European players to enter into technology transfer and license agreements with CSR and CNR, the two companies which merged to form CRRC. Even today many European players continue to offer these licence agreements and joint ventures, which are a key part of CRRC's offer to its domestic market.

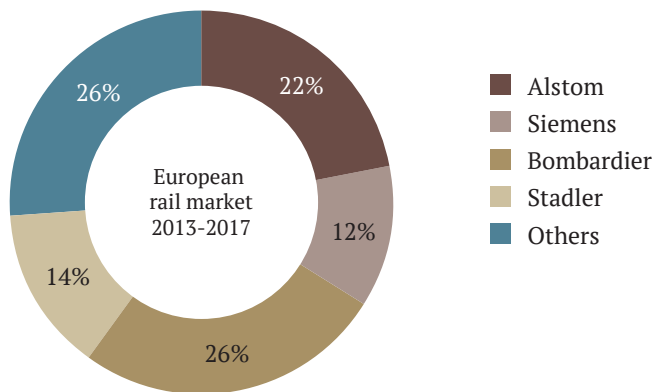

Fig. 2. European rail market shares in period 2013-2017

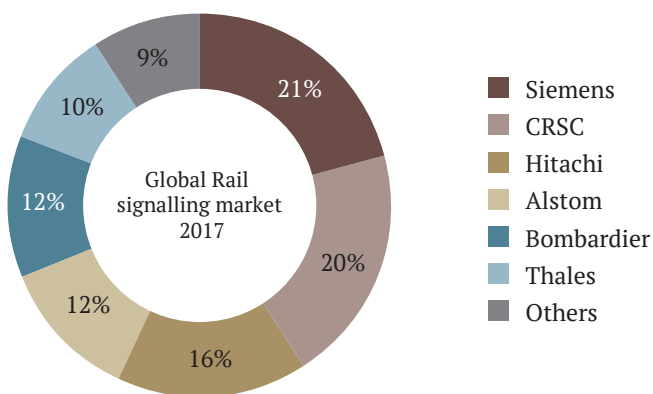

Fig. 3. Global rail signalling market shares 2017

Despite the existence of a free and open market, the European rail market remains largely distributed among European-based suppliers, as shown in Figure 2.

To secure approval for the deal, it seems likely that Alstom and Siemens will have to offer a combination of behavioural and structural remedies.

When it comes to rolling stock, Siemens and Alstom seem at a first glance not to have much overlap. However, in the case of long-term lifecycle/maintenance contracts, the merger could create a situation where operators are facing a situation where competition is threatened. In particular, there are likely to be issues with signalling system operations, particularly following previous market consolidation where Alstom took over GE Signalling and Siemens acquired Invensys.

The global rail signalling market and the market shares of the leading companies are shown in Figure 3.

This could potentially open the floor to signalling competitors Thales and Bombardier Transportation, or it may be that roll-

ing stock producers such as Hitachi and Stadler Rail could look to optimize their own portfolios by purchasing any assets put up for sale. Stadler has already taken its first steps into the signalling market by establishing the AngelStar ETCs joint venture with Mermec. It is also conceivable that Knorr Bremse and Vossloh owner Mr Thiele may look to add assets to either or both of Vossloh or Knorr Bremse.

More likely is the merger's negative impact on smaller rivals by squeezing them out of joint bids for big orders. The European Commission may seek assurances from Siemens and Alstom to keep partnering with or to license products to some smaller firms. Other manufacturers are expected to fight to secure future protection against the industry giant.

Beyond the European Union, Siemens and Alstom's participation is likely to be investigated by local anti-trust authorities. One example could be Russia where Siemens holds a 50% stake in Ural Locomotives and in Siemens Elektroprivod. Alstom similarly holds 33% of Transmashholding. Together both companies dominate the Russian mainline and urban rail market, accounting for more than 80% of recent orders.

Russian Railways (RZD) and other Russian operators may have concerns over whether the new company will retain these holdings in the future, and if they do, the potential risks of creating a monopolistic player in the rolling stock market.

The Russian Law on Protection of Competition (LPC) entered into force in October 2006. The latest amendments to the LPC concern the merger control rules, which came into effect on January 7, 2017. The LPC governs, inter alia, merger control in commodity and financial markets and applies to the transactions in which the targets are Russian entities or foreign entities operating in Russia (including those without a physical presence). Under the LPC, foreign mergers are subject to Russian merger control if they have or may have an impact on competition in the Russian Federation. The acquisition of shares, resulting in the acquirer and its group holding directly or indirectly holding more than 50 per cent of voting shares, or the right to determine the business

activities through shareholdings, agreements, voting arrangements, rights, etc. of a foreign company is subject to Russian merger control rules if the target's Russian turnover in the preceding year exceeded Roubles 1 billion (approx. 13,1mln EUR). The Russian merger control provisions are enforced by the Federal Antimonopoly Service (FAS).

As well as Russia, other major markets or regions such as India, China and potentially the United States may also scrutinise the merger in more detail.

Siemens and Alstom have already set themselves a key milestone to become a «champion in mobility». On March 23, 2018 both companies entered into a Business Combination Agreement (BCA) regarding the proposed combination of Siemens' mobility business, including its rail traction drive business, with Alstom. This BCA follows the Memorandum of Understanding signed on September 26, 2017 and the conclusion of the required works council information and consultation process at Alstom regarding the proposed deal. The BCA sets forth the terms and conditions agreed upon by the two companies.

Both Alstom and Siemens also confirmed the proposed leadership of the future Board of Directors of the new company, which will consist of 11 members, six of whom – including the chairman – will be appointed by Siemens with four independent members and the CEO completing the board. Siemens is proposing to nominate Roland Busch, a member of the Managing Board of Siemens AG, to serve as chairman of the combined entity's Board of Directors.

The transaction is subject to the approval of Alstom shareholders at the company's Shareholders' Meeting, in July 2018. The transaction is also subject to approval by relevant regulatory authorities, including foreign investment clearance by the French Ministry for the Economy and Finance and approval by anti-trust authorities as well as the confirmation by the French capital market authority (AMF) that no mandatory takeover offer will be launched by Siemens following completion. Siemens has already initiated the internal carve-out process of its mobility business and other related businesses in or-

der to prepare for the combination with Alstom. The new group will be headquartered in Saint-Ouen, France, and continue to be listed on the Paris stock exchange. As part of this transaction, Siemens will receive newly-issued shares in the combined company which represent 50 percent of the share capital of Alstom on a fully diluted basis.

With regard to the global rail industry, major regional investments in markets such as China, India, Turkey and South Africa, and the strict requirement for localisation of production, will continue to alter the global landscape of the rail industry. The rail industry circus will follow the major investments around the world, finding new places to establish its tent and manufacture equipment and products. In the first step of this process, these investments are project-related and mostly paid for by the customer. But if sustainable growth and stable regional development is assured, new players will emerge. The merger of Siemens and Alstom is one approach to meeting this challenge. However, it will ultimately be down to the political decision makers combined with the supporting investment and development banks to create a market environment that is able to support sustainable economic development, and encourage further globalisation of the rail industry and manufacturing sector. Market barriers will not help to prevent intruders and only by adopting more cooperative approaches will the rail industry prepare for tomorrow.

The globalisation of the rail industry, and the structural changes taking place in the market, cannot be prevented. No market barriers are able to stop the winds of change or perceived intruders from taking their place. The rail industry has and will continue to create cooperative approaches which will help prepare it for tomorrow. Following the Siemens Alstom merger, more consolidation is expected to take place. But this is not just a response to the challenge posed by CRRC, but to create healthy and profitable companies which provide secure places of employment and also safeguard railway operations in favour of passengers and freight customers. The shake up started in the 1980s and the market is continuing to evolve as the industry reaches its next stage of development. 

Digital Railway: from Concept to Reality



Efim Rozenberg

Doctor of Engineering, Professor, First Deputy Director General at The Russian R&D Institute of Informatisation, Automation and Communication (NIAS)

In the coming decades, the mass deployment of digital technologies will accelerate the development of Russia's industry and economy. Russia's national development guidelines identify Russian Railways (RZD) as a crucial actor in the process to overcome the complex social and economic challenges which could significantly impact opportunities for industrial growth. By establishing new transport and logistics routes, RZD will help to serve the needs of both the Russian and global economies as well as provide quality services to the general public.

A three-fold objective

The Digital Railway concept adopted by the Russian railway industry outlines a range of information technologies, processes and integrated standards that reflect three overarching business principles: complete consistency, online business and service management. These principles cover all areas of the sector's activities and are protected by state-of-the-art information security mechanisms. Future delivery of these principles should be based on the deployment and ongoing improvement of automated solutions that can be effectively and rationally applied to the service blocks of the Digital Railway model developed by Russian Railways (RZD) while complying with the organisational and technical standards to enable service block interaction.

RZD is the largest owner and operator of rail infrastructure in Russia. The company's permanent assets are worth Roubles 261bn while its infrastructure division employs nearly 335,000 people who maintain 150,000km of track, 30,000 bridges and overpasses, 159 tunnels, over 5,000 stations and many other facilities. Today, more than 16,000km of main line tracks are represented as digital track models, while over 18,000km of track is covered by a high-precision coordinate network.

RZD is also a major owner and operator of telephone and radio communication net-

works, including digital radio DMR, TETRA, and GSM-R. The total length of RZD communication lines exceeds 330,000km while its fiber-optic communication lines total more than 77,000km.

More than 500,000 signalling equipment units and more than 6 million sensors of various types as well as diagnostics and telemetry devices are operated across the railway network. Managing a system this complex was only made possible through the introduction of advanced automation facilities and technologies. Innovative systems incorporate advanced information technologies that enable a significant improvement in the range and quality of the transport and logistics services available in the market. Addressing the Federal Assembly of the Russian Federation, President Vladimir Putin challenged the sector to increase the integration of Russia's transport system with international transport corridors. This is a logical step. An analysis of the logistical environment on existing Asia – Europe routes show that the Russian Federation's geographical location, its strong existing transport network and port infrastructure can support reliable and safe freight movement between continents. The land journey by rail can take up to 10 days less than the equivalent combined journey around the African continent, which is an undeniable competitive advantage.

Real-time logistics

Increasing the railway system's capacity by introducing intelligent control systems and reducing infrastructure and rolling stock lifecycle costs, facilitates the establishment of new transport corridors. Information and computer-based process control systems can similarly increase labour productivity and reduce the effects of human error on performance helping to deliver the required level of information security.

The main focus of the Digital Economy of the Russian Federation programme roadmap is to develop the platforms, technologies, competencies, infrastructure and institutional environment required by the future markets and industries in the digital economy.

RZD's Digital Railway programme consequently encompasses each of the digital technologies development areas included in the Digital Economy of the Russian Federation programme: Big Data, Industrial Internet of Things (IIoT), wireless communication, neural networks and artificial intelligence, blockchain, and virtual and augmented reality.

RZD is a major owner and operator of data processing centres, computer facilities, and data storage and processing infrastructure. The railway runs 18 data processing centres distributed throughout the country serving every federal district. RZD's server equipment stock exceeds 78,000 units, including high-reliability clusters of mainframe-class server equipment.

RZD is not only a major consumer of innovative solutions, but it also owns an advanced industrial engineering and research complex, NIIAS, which supports the company's strate-

gic development and global competitiveness by enabling the railway to develop and implement advanced digital technologies.

Following the decision to create the Intelligent Process Control and Automation System for Railway Transport platform, RZD proceeded to implement the Digital Railway. The deployment of information technology in the railway industry, creation of high-speed engineering communication networks, and the development of advanced software and hardware systems are the foundations of the technical and process-management requirements for the digitalisation of railway transport. Today, we possess extensive information on the process, but the level of automation remains insufficient due to the absence of a close association between the lower level automation devices, information systems and control elements within a single structure. Without complete control, no effective Big Data solutions are possible.

The Digital Railway is seeking the complete integration of the user, the vehicle, and the traffic and infrastructure control system. The objective is to create new end-to-end digital technologies that help to better organise the transport process. Accomplishing this task requires improvements to railway signalling systems, creation of digital infrastructure models and deploying digital communication networks which can support train separation, technical equipment condition monitoring and process automation systems.

In response to these needs, over the past few years, the industry has created the required conditions for the introduction of a complex set of innovative technologies envisaged in the Digital Railway concept.

«Seamless» technologies

The following technological foundations are the basis of the migration to a future Digital Railway:

- Digital models of infrastructure assets in a common coordinate-temporal space.
- Digital communication networks and high-precision coordinate systems based

on high-precision satellite positioning networks.

- Continuous monitoring of infrastructure assets with automatic generation of speed restrictions and maintenance plans.
- Rolling stock condition monitoring using both external and internal facilities with

the capability of predicting the residual operating life.

- Computing facilities capable of remote control of infrastructure assets, real-time modification of traffic schedules with regard to energy efficiency and automation of individual operations, and
- Mobile facilities supporting personnel while on location and providing psycho-physiological condition supervision.

All of these elements are integrated into a single technical processing network.

Digital displays of infrastructure assets within the framework of high-precision coordinate technologies is a necessary condition for the migration to the Digital Railway as it enables passenger and freight trains as well as maintenance and measuring equipment to operate using the same technology.

Given the vastness of RZD's railway network, it is apparent that high-precision satellite positioning is the only option that will effectively serve these demands.

Digital track models (DTM) of lines in operation and station layouts as well as 3D models of track layouts and engineering construction are created based on coordinate-referenced spatial data. These digital models provide spatial descriptions of infrastructure assets, including railway track, engineering construction sites, power supply and railway signalling and communication systems.

The rapid development of high-precision satellite positioning technologies opens a new page in research, design and construction of railway transport infrastructure, including the use of Building Information Modelling (BIM) technologies.¹

BIM is based on differential correction principles offered by the navigation data provided by the global navigation satellite system (GNSS).

The use of this technology creates the basis for the transition to coordinate methods of infrastructure maintenance, the organisation of cross-cutting design, new construction and infrastructure facility maintenance technologies, all of which can offer reductions in life-

cycle cost and improvements in the required level of reliability and safety.

The station is a key element of the transport process. It is therefore necessary to create a digital model that can assess the impact of all infrastructure on operations at any station. We already have considerable experience in modelling similar complex objects which can help reduce the amount of work that this project will require, with the Moscow Central Circle (MCC) one such example.

One of the important elements that supports the future automation of technological processes control at stations was tested at Yaroslavl-Glavny station on the North Main Line. Among the innovative solutions used was satellite navigation, which provided a technical vision for the future locomotive coupling/uncoupling process as well as video recognition of wagon numbers and the control of employees in hazardous areas. Significant progress was made in the automation of the train splitting and formation process by improving the marshalling system at Luzhskaya station on the October Railway. Here a unique system was developed by integrating Radioavionika's microprocessor-based interlocking system, EC-EM, with Siemens' MSR 32 microcomputer system for marshalling yards, NIIAS' MALS automatic cab signalling system for shunting vehicles, and the automatic hump locomotive operation system SAU GL developed by Russian scientific research and technological institute of rolling stock (VNIKTI).

These technologies were presented to President Putin at Chelyabinsk station with demonstrations of parallel humping and humping control using a driverless shunting locomotive. In addition, further innovations at Chelyabinsk and Luzhskaya provide examples of finished elements of the Digital Railway. These include an automated station control system (ASU ST); driverless shunting locomotive control system (MALS BM); integrated system for automated control of shunting operations (KSAU SP); an automatic rolling stock diagnostics system (PPSS); and automatic cab signalling shunting system (MALS).

¹ BIM (Building Information Modelling or Building Information Model). Building information modelling is an approach to construction, operation, maintenance and renovation of a building (object lifecycle management) which involves collecting and processing building data. Specifically, this covers architecture, design, technology, economic and other information and their interrelations and dependencies when the building and everything that related to it, are treated as a single object.

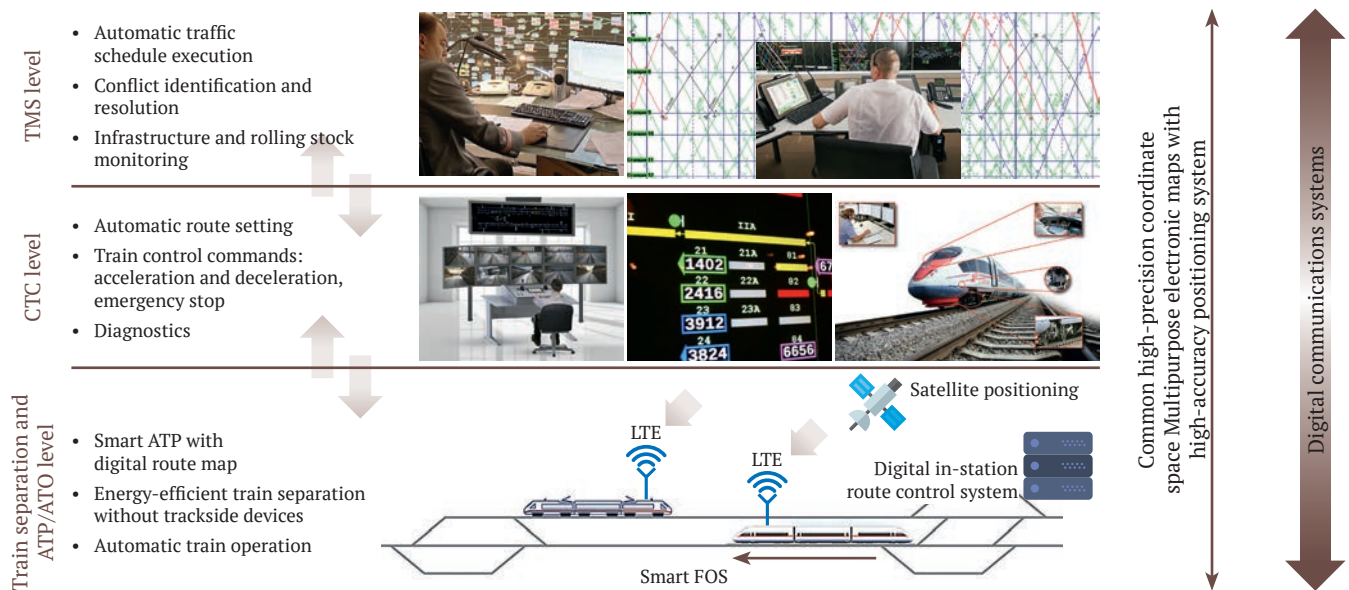

Fig. 1. RZD management and information system

A clear outlook for tomorrow

The MALS system, which ensures the safety of shunting operations, is fully compliant with the requirements of the Digital Railway project. It is based on digital station model, digital radio channel, satellite navigation and safe computing modules.

Onboard microprocessor-based control and safety systems are also becoming integrated complexes with Sinara Transport Machines and Transmashholding already performing related technical tasks.

The Digital Railway's management and information systems require the automatic acquisition of information from the technological process as well as the transmission of control commands to executive objects such as onboard systems and route control systems at stations.

RZD management and information systems can be generally divided into three levels. On the upper level control commands from the Intelligent Railway Transportation Management System (ISUZhT) can optimise traffic scheduling by offering conflict identification and resolution.

The middle level supports automatic route setting at stations, transmitting information about schedule changes to locomotives and obtaining coordinates and movement parameters from all mobile units. Infrastructure

diagnostics from rolling stock should also be included at this level.

The third and the most critical level consists of wayside and onboard device control systems such as train separation and points and signal control at stations (fig. 1).

Currently all three levels are hardware and software complexes with increased safety requirements.

NIIAS has implemented a set of technical means for transmitting critical information retrieved from SAUT-CM/NSP equipment on the condition of lines and stations to onboard safety devices at Podlipki-Dachnye station on the Moscow Railway. The general level of traffic safety was increased by transmitting information about entrance/exit routes and automatic cab signalling codes to onboard devices. The use of a supplementary radio channel between fixed and locomotive devices has increased the reliability of signalling and interlockings.

In the context of the migration to the Digital Railway, significant attention is being paid to improving information delivery systems. In particular, digital radio communication and the transmission of technical data are priorities while new computing facilities are able to process more information, significantly reducing the reliance on a number of lower level devices including those deemed part of the In-

ternet of Things (IoT). Large stations assume the functions of the lower links, supporting the transition to centralised management.

Currently advanced diagnostics devices are being developed and implemented across the network, providing an evaluation of the technical condition of locomotives, and signalling and interlocking devices. They also read, aggregate and transmit data from fixed observation and diagnostics installations, such as acoustic and thermal imaging devices. In this new system, the locomotive has effectively become a mobile diagnostics centre that receives information from wayside automation devices. This has helped to significantly reduce operation costs, free up labour resources by enabling the introduction of reduced teams and unmanned operation, and altered the role of train, station and hump yard control systems.

Similarly, a multi-purpose radio communication unit, the onboard navigation and communication device (BRUS), is able to work simultaneously across several communication channels. BRUS hardware was selected as it possesses significant computing power and interface connections and its capability to function as a single intelligent modem pool for all devices, systems and units installed onboard the locomotive. In addition, the system can work with any available and newly-created communication standard.

An advanced communication system is an essential element of the Digital Railway. It contains both established operational digital communication solutions via fiber-optic line (FOL) and new elements necessary for the implementation of promising technical solutions such as LTE data transmission, IoT and the Universal Time System.

A multi-level control system and digital radio channel reduce the time lost from technical failures while increasing the speed of movement on existing and future lines. These issues have already been tested during the project to increase speeds on the Moscow – Nizhny Novgorod line.

Automatic train operation requires the use of a digital radio channel for data transmission. This channel must be both reliable and guarantee the security of transmitted information. Technical solutions which support the implementation of such a system are in use

on the MCC where warnings are automatically transmitted onboard the ES2G Lastochka EMU fleet.

The control of large sections of points and signals requires the transition to a universal structure, where a single base station controls a dozen smaller stations. Such a project is already being implemented on the North-Caucasian railway.

Next-generation train separation is a critical component of the gradual shift to automated train traffic control. The transition from colour light signalling to signal-free traffic control as well as the use of a digital radio channel is an additional control element which will support reduced headways of two to three minutes. Again, this approach has already proved successful on the MCC.

The digital system of integrated automatic traffic management is a three-level system. The initial information environment, which ensures traffic safety, consists of low-level automation devices, with modern computer facilities processing the data. With the results of this information processing meeting information and functional safety requirements, they can be used directly to control station devices and rolling stock.

Within the framework of the Digital Railway project, the development of driverless train control systems is underway both for shunting operations and the MCC. Russian inventions meet international regulations and correspond with similar technical solutions developed according to UIC standards. In accordance with IEC 62290 the level of automation meets the requirements of GoA3, with a single driver operator able to control up to 10 trains.

Fully automated infrastructure, rolling stock monitoring and traffic control, all of which offer significant improvements in energy efficiency and performance through reduced human, and in some cases unmanned operation, are key elements of this new transport process. Modelling of track capacity and passenger traffic flow data at all infrastructure points is another essential component of this process and is an approach similar to the work underway at major international railways to develop new integrated multimodal transport systems. Together, they form the basis for a transition to the Digital Railway. 

Regulatory changes seek to encourage third-party investment in passenger rail



Ilya Tereshko

Deputy Head of Railway Research Division at Institute of Natural Monopolies Research (IPEM)

Russia's passenger rail sector is experiencing dramatic changes in its regulatory environment. By softening entry barriers and making the segment more transparent and reliable by providing guarantees over long-term subsidies, the Russian government is looking to spur market competition, which it hopes will result in improved service quality and make the sector more attractive to third-party financial investment.

Until recently, there were three main issues impacting the performance of the suburban passenger rail sector in Russia: the absence of any long-term infrastructure fee subsidy policy, a long-term value-added tax (VAT) collection policy, and the rapid ageing of rolling stock used on these services.

The Russian government has subsidised 99% of the infrastructure fee paid by every suburban railway operator to the infrastructure manager, Russian Railways (RZD). However, a long-term government decision on how to allocate these subsidies was not forthcoming, with a decision made annually and repeated year-on-year. This scenario would leave transport operating companies (TOCs) vulnerable if the government decided to stop subsidising infrastructure. Indeed, TOCs faced the risk of a 100-fold increase in their infrastructure fees, which may account for up to 30% of their total costs, should the government pull or cut back support. The TOCs had a taste of what this could mean in 2015 when for two months infrastructure subsidies were cut from 99% to 75%. With many TOCs suffering from cashflow problems, some services were suspended until the subsidies were restored.

A similar annual approach was taken to the VAT strategy. Russia's suburban railway services are exempt from VAT on ticket sales. However, TOCs have to pay VAT when paying their suppliers. At the end of the fiscal year, the government would grant the right to retrieve the VAT paid by TOCs to their suppliers, back to TOCs from the federal budget. But

again, there was no long-term strategy for this policy with the government decision made and repeated annually.

The suburban TOCs are also hindered by rapidly ageing rolling stock. Following the restructuring of the suburban sector, RZD effectively became the infrastructure manager, with operations provided by the TOCs, many of which are RZD subsidiaries. As a result, RZD no longer included investment in suburban rolling stock in its annual budget, with renewal now an obligation of the TOCs. Yet with the planning horizon defined by annual government decisions, the TOCs were prevented from developing any long-term strategies, calculating potential return on investment, and starting any negotiations with financial institutions to secure sufficient resources to support procurement.

With the rolling stock procurement issues directly related to the problems with VAT and subsidies, the Russian government has focused on developing a long-term policy in these areas. In 2016 two federal laws supporting development of the suburban railway sector were passed, which included a commitment to spend \$US 800m annually, an unprecedented level of government financial support. The first law reaffirms the government's 99% infrastructure fee subsidy for a period of 15 years, with the government allocating around \$US 620m annually until the end of 2030. The second law affirms the VAT refund right for TOCs for 15 years, equivalent to around \$US 180m annually until the end of 2029.

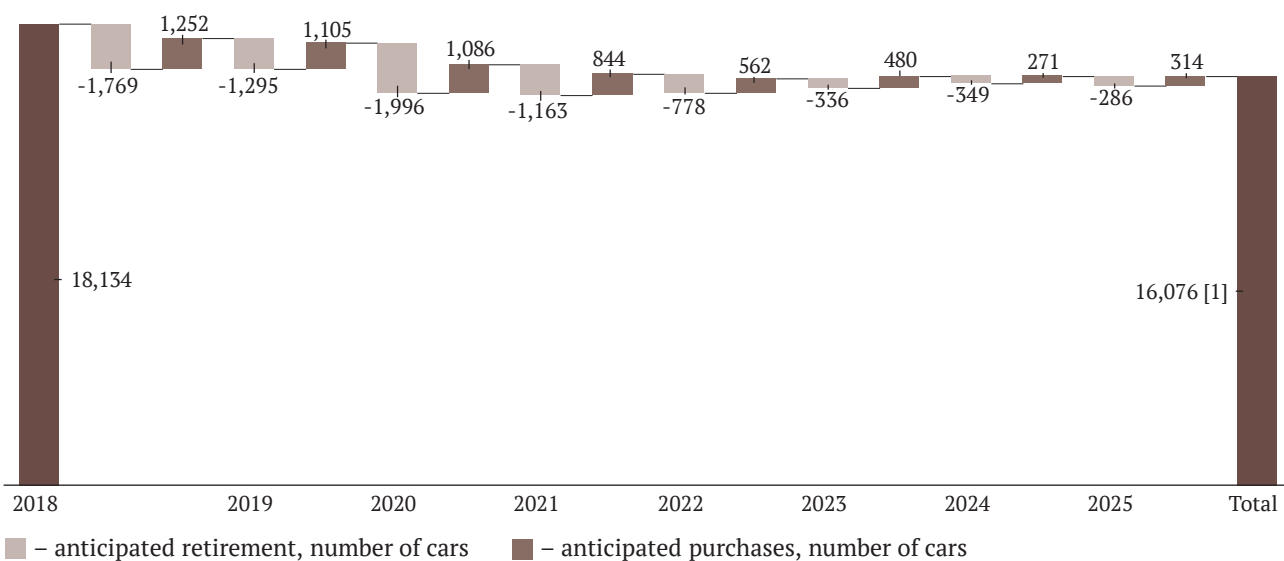

[1] – Total purchases do not exceed the number of coaches that are expected to retire mainly due to anticipated increases in operational efficiency and the replacement of some single-deck coaches with double-deck vehicles.

Fig. 1. Anticipated retirement and purchase figures for long-distance passenger coaches

Such long-term financial obligations are unique for the Russian railway industry and the economy as a whole. Since the reforms were introduced, the suburban railway sector has been able to break even, which has led to an increase in the attractiveness of prospective investments and greater investor interest in suburban railway TOCs, reflecting the perception that investment carries less risk. For example, in November 2017 a strategic investor acquired a 25% equity stake in the leading suburban TOC in Russia, Central PPK, from RZD. Central PPK operates nine out of the 10 major lines serving the Moscow region and has a 65% share of Russia's total suburban passenger market. In January 2018, another strategic investor bought almost 13% of Central PPK from the Moscow regional government. With government support guaranteed for the next 15 years, the risk of this investment has been reduced substantially, and at the beginning of the 15-year period, the time is ripe for third-party investment in the sector.

The Russian government has also encouraged regional authorities, which are responsible for providing people with transport services, to sign long-term contracts with TOCs to guarantee TOC revenue streams and encourage rolling stock investment. Moscow, Moscow region, Ryazan region, St Petersburg and others have already signed

15-year agreements. In addition, in 2018, some regional transport entities, which are TOC shareholders, began the acquisition of rolling stock for TOCs by themselves by allocating funds from regional budgets.

The government's policy changes have created an environment where it is now possible to solve the rolling stock renewal problem. The guaranteed subsidies have dramatically reduced the TOCs costs over the next 15 years, which has enabled some TOCs not only to break even, but to become profitable. Secondly, with no risk of a sudden increase in expenditure, the TOCs are now able to accurately forecast potential costs, incorporate these costs into financial and investment models, develop long-term business plans as well as start negotiations with financial institutions and leasing companies on obtaining financial recourses for rolling stock procurement. For instance, Central PPK has already bought 86 11-car EMUS and is developing extensive plans to spend \$US 3bn on renewing 50-60% of its fleet, or more than 2,000 cars, by 2025. Others are following this lead. In 2016, Severo Zapadnaya PPK, which serves the St Petersburg region, and Saratovskaya PPK started buying new rolling stock.

This new environment which is encouraging rolling stock investment is inevitably improving the prospects of suburban railway rolling stock manufacturers and spare parts

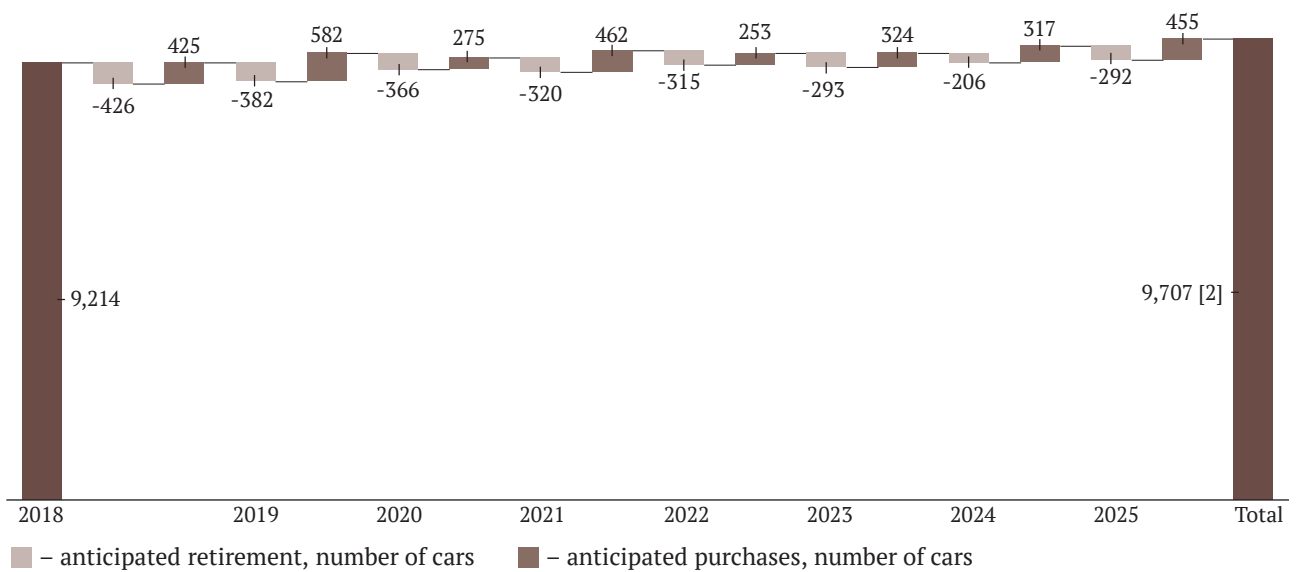

[2] – purchases exceed retirement mainly due to expected increases in passenger turnover and the launch of services to new destinations.

Fig. 2. Anticipated retirement and purchase figures for suburban passenger coaches

suppliers. In addition to Central PPK's vast rolling stock renewal programme, more than 1,100 suburban railway vehicles used by oth-

er TOCs are due for replacement or renewal up to 2025, which could potentially add another \$US 1bn to manufacturers' order books.

Long-distance passenger railway transport

The long-distance sector suffers from similar issues with ageing rolling stock and a shortage of investment resources. According to recent estimates, around 5,900 or 30% of long-distance passenger railway vehicles should be replaced or renewed by 2025, which may require an investment of up to \$US 4.5bn.

Two special government documents intended to change the regulation environment for long-distance passenger services, are expected to be issued in the near future. Ticket prices for some long-distance services are currently limited by the federal government, with the difference between a profitable price level and the limit set by the government compensated from the federal budget. The first document is expected to propose that in the future TOCs will bid to operate long-distance services and the level of compensation they will receive from the government. The second document will look at reducing market entry barriers for new TOCs and will set the stage for the development of a competitive long-distance market.

The combined purpose of both documents is to challenge the domination of Federal Passenger Company, which has a market share of more than 90%. Regulatory environment change is expected to stimulate market entry by new players, trigger competition development, increase efficiency and improve the quality of services.

The hope is that a renewed regulatory environment and the development of competition in the sector will prompt private investment in the long-distance sector, which will help to solve the problem of ageing rolling stock. Furthermore, potential market structure changes together with high rolling stock renewal demand is expected to make an impact on long-distance rolling stock manufacturing, inducing very high production volumes and the development of new technologies.

The documents have been forwarded by the Ministry of Transport to the Russian government and are currently undergoing an approvals process by other relevant state authorities. 

What role can CNG and LNG play in railway transport?



Michele Molinari
CEO and President
of Molinari Rail Group



Jan Harder
CEO, Molinari Rail Systems

This article discusses the use of LNG and CNG-based fuels for rail operations, considering the advantages and disadvantages and the vision for their future use.

Prerequisites

Railways have a long history of cooperating in the development and implementation of innovative fuel solutions that act as an alternative to gasoline. In particular, BNSF and Union Pacific in the United States have more than 30 years of experience in this area, producing a variety of solutions. The need for these projects is obvious. According to the Interstate Commerce Commission, fuel is the second largest source of expenditure for US Class 1 railways.

In other countries similar fuel development projects have taken place. For example, in France the use of alternative fuels dates back more than 30 years. The first TGV prototype, TGV 001, was powered by a gas turbine. However, the high cost of oil prompted the change to overhead electric lines for power delivery. Nevertheless, two large classes of gas-turbine powered inter-city trains, ETG and RTG, were constructed in the

early 1970s and were used extensively in France up to about 2000. In addition, French National Railways (SNCF) used a number of gas-turbine trains called the Turbotrain on non-electrified lines. These sets typically consisted of a power car at each end and three intermediate cars, with Turbotrain in use up until 2005. After retirement, four of the sets were sold for further use in Iran.

Operators and manufacturers have always paid close attention to the development and use of alternative fuels as a means of reducing costs, improving the efficiency of operations, and satisfying increasingly strict emission regulations. Today there is significant discussion over whether LNG and CNG-based traction can deliver the advantages that rail operators from around the world are looking for and become the alternative fuel of choice.

Functional aspects

Liquefied Natural Gas (LNG) is a cryogenic hydrocarbon fluid that is used as a fuel for engines used in transport vehicles, including trains. Due to its cryogenic nature, the liquid's composition can vary during transport from the liquefaction plant to the filling base, and from the filling base to the LNG storage system. As a result, it is necessary to adopt a single regulatory framework to guarantee a consistent LNG composition in order for the end user to operate LNG-powered vehicles in accordance with operating rules.

Due to its volatility, the effective use of LNG in transport requires certain conditions to be maintained, including keeping the fuel within

a specific temperature range and a relatively low pressure. Transporting the fuel from processing plants to the end user can easily result in the transfer of heat energy to the fuel, changing its composition. It is essential then to define the minimum requirements within a single regulatory framework for the composition of LNG during transport, and unified standards for transport and storage of LNG all of which also meet the strict standards for the production of the gas.

Railway operators have been experimenting with the use of gasoline fuel in rail transport since 1935. The following are the three main

methods for combustion of gas engine fuel in large cylinder and high-power diesel engines:

- spark ignition
- ignition by compression (at low pressure), and
- ignition by compression (at high pressure).

In the final two combustion methods, which use an air-fuel mixture, a preliminary injection of diesel fuel - the ignition of this process - is envisaged when the oxidant is squeezed into the engine cylinder. Gas-powered fuel is subsequent-

ly injected directly into the inlet pipe of the engines or directly into the combustion chamber. During recent decades, operators and manufacturers have accumulated varying competences in the first two methods. However, governments and regulatory bodies have chosen to introduce increasingly strict regulations on the quality of exhaust fumes and levels, particularly relating to noxious and toxic substances, and we expect that this trend will continue in the future.

Practical aspects

It is also important to note the experience of using gas turbine units for diesel traction. In 1953, Richfield Petroleum Corporation and Union Pacific launched a joint programme where a UP57 gas turbine locomotive was operated between Los Angeles and Las Vegas for nine months using liquefied petroleum gas (LPG). The capacity of the locomotive was 4,500 litres and it was fitted with a special tender to store the LPG. While there were no technical barriers to the further development of this project, it was suspended due to low fuel efficiency. It is important to note the peculiarity of the operation of gas turbines in that at a relatively low power, compression-ignition engines have a high efficiency, since the thermodynamic cycle of compression ignition engines is closer to the ideal Carnot cycle.

The following is a visualisation of caloric content of three types of fuel: compressed natural gas (CNG), LNG and diesel. This visualisation relies on data retrieved from several operational locomotives, including the EMD GP9 shunting locomotive, which with a power rating of 1,750, creates thrust using a 16-cylinder two-stroke reciprocating engine at 567C with spark ignition.

The graph shows that the locomotive's range when using CNG with an equal fuel storage volume is 2.4-times less than the range of an equivalent locomotive that uses LNG. Let's assume that, with other things being equal, the efficiency of the engines is the same. In this case the range of the locomotive that uses diesel fuel is 1.75-times greater than that of the locomotive using LNG. Thus, based on the caloric content of LNG and CNG, it is necessary to create a new operating manual for locomotives that use LNG and CNG when designing a new storage and filling system. The diesel locomotive fuelled by LNG requires a LNG stor-

age tender, which will result in a reduction of the number of freight wagons that the locomotive is able to haul, limiting its range of operation, and an increase in the composition's weight. The cost of such a tender is around \$1m as of May 1 2018.

Burlington Northern's chemical company, Air Products & Chemicals, initiated a project to use liquefied methane in rail transport in 1987. This project included the design and construction of a tender to couple with the locomotive and fuelling stations. It also involved the upgrade of an EMD SD40-2 diesel locomotive, which has a capacity of 3,000 rpm and uses a 16-cylinder compression ignition engine. The modernisation kit included a low-pressure gas supply system and used diesel as a back-up fuel as well as exclusively during starting, idling and low positions. The gas supply system included a special evaporator through which liquefied methane was sucked from the tender, with the supply of methane in a gaseous state taking place in the engine's inlet at a pressure of 586kPa. This technology was tested over a long period of time and is now available commercially with the EMD 16-645E3B engine available as an upgrade kit for mainline diesel locomotives. The engine's design has undergone significant improvements since it was first developed, specifically the design of the piston, cylinder head, fuel

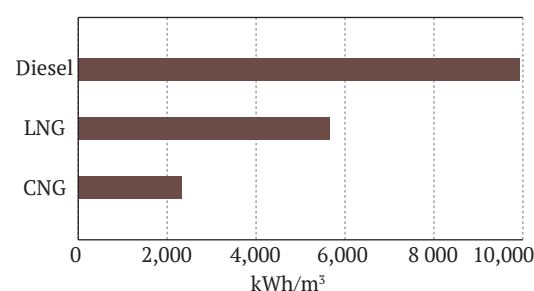

Fig. 1. Visualization of caloric value of fuels

supply system, the diesel fuel inlet, inlet channels for gas supply, and the electronic control system.

In September 2014, GE Transportation, in conjunction with CSX, carried out tests with a gas-diesel locomotive connected directly to a LNG storage tender. In this system, the gas is fed under low pressure directly to the intake valve, where a priming dose of diesel fuel is used for ignition. This technology uses a catalytic system to minimise harmful emissions and complies with the United States Environmental Protection Agency's Tier 3 emission regulations. The tests found that it is possible to reduce the volume of diesel fuel used by the locomotive by up to 80%. Following the success of these tests, the technology is now commercially available as an upgrade kit for GE's Evolution locomotives.

On November 9 2017 Florida East Coast Railway (FECR) officially unveiled its modified fleet of 24 GE ES44AC locomotives, which operate in pairs and utilise a purpose-built fuel tender supplied by Chart Industries, United States.

FECR is the first railway to haul LNG as a commodity under a Federal Railroad Adminis-

tration (FRA) waiver. The fuel has been adopted by FECR as an alternative to diesel for two reasons. Firstly, FECR's line-haul locomotive fleet is captive, operating solely on the Jacksonville - Miami main line. Secondly, FECR has access to a ready source of LNG through Florida East Coast Industries' LNG plant at Titusville. The EPA Tier 3-compliant locomotives look identical to standard ES44ACs, but their GEVO prime-movers have been retrofitted by GE with its NextFuel low-pressure technology. According to the manufacturer, NextFuel provides railways with the flexibility to run on both diesel fuel and LNG with up to 80% gas substitution or 100% diesel.

Russian gas company Gazprom also entered the alternative fuel arena recently with its order for 24 LNG locomotives from Sinara Transport Machines, a Russian company based in Yekaterinburg, for use on its line in the Yamal Peninsula. Sinara is set to deliver 10 0.9MW and 14 1.5MW locomotives by 2024 with the locomotives expected to haul 8200-tonne freight trains and reduce the operator's fuel costs by up to 40%.

Conclusion

The use of LNG and CNG as fuels for locomotives and rolling stock remains experimental. Long-standing operations in the US and France show that commercial use is not competitive with equivalent electric and diesel operations. While more environmentally-friendly than older fleets, LNG and CNG do not outperform other alternative fuel technologies such as hydrogen, fuel cell, battery or bio-gas in terms of CO₂ emissions. LNG and CNG locomotives also require extensive new infrastructure for fuelling, restricting use, as shown in Florida and on the Yamal Line, where operations are limited to a single line rather than across an extensive network. The use of LNG and CNG locomotives will therefore be limited to industrial operations and use is unlikely to be widespread. Of course, with regard to diesel traction, LNG and CNG traction is an alternative which offers lower operational costs provided the costs for generation, transport and buffering are not too high or the type of fuel is already generated. However, for widespread optimisation of rail networks and to better address climate change,

electrification is the preferred path to success. «Hydrail» activities will accompany this on lines not suitable for electrification and will offer much greater CO₂ benefits than any other solution.

The noise emitted by LNG and CNG locomotives will similarly restrict their use for passenger operations or in urban areas due to legal requirements. Here battery, electric and hydrogen solutions offer greater advantages for new fleets.

We assume that in the future the search for alternative sources of energy will focus on optimising electric OCS-based power and here especially the source of that electricity will be wind, as shown recently in the Netherlands. On the other hand, the performance and use of new technologies such as hydrogen fuel cells and batteries will continue to improve and increase in upcoming decades. This will be accompanied by new solutions to reduce the overall energy consumption of rail operations such as the Auxillary Power Unit developed and manufactured by Molinari Rail for the new diesel-electric locomotives that GE is building for Indian Railways. 

union of
industries of
railway
equipment

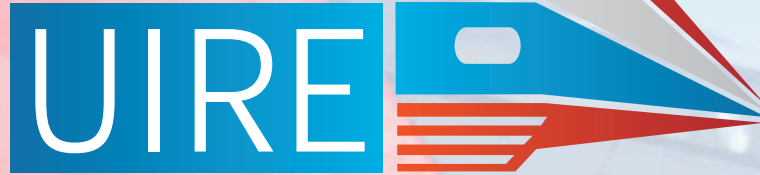

UIRE NP consists of 156 enterprises from 34 Russian regions that manufacture 90% of all rail production in the RF. Goods turnover of the enterprises of the partnership makes up more than 380 billion Russian roubles. Enterprises from Ukraine, Belarus, Germany, Uzbekistan, the Slovak Republic and the Republic of Kazakhstan involved in the activities the partnership.

COOPERATION OF UIRE NP WITH INTERNATIONAL ORGANIZATIONS FOR ACHIEVEMENT OF STATUTORY OBJECTIVES OF PARTNERSHIP



DIE BAHNINDUSTRIE.
VDB VERBAND DER BAHNINDUSTRIE IN DEUTSCHLAND E.V.

German Railway
Industry Association (VDB)

BAHNINDUSTRIE.at
Verband der Bahnindustrie

Austrian Railway
Industry Association



ACRI

Association of Czech
Railway Industry (ACRI)

SWISSRAIL
Industry Association

SWISSRAIL Industry
Association (SWISSRAIL)



Association of
American Railroads

Non-profit partnership «Union of industries of Railway Equipment» (NP «UIRE») is founded in June, 2007 in Russia by the companies of Russian Railways, Transmashholding, Kontsern Traktornye zavody and Holding UK «Russian Corporation of transport machine-building»

3 Rizhskaya Square,
107996, Moscow
Tel.: +7 (499) 262-27-73
Fax: +7 (499) 262-95-40
www.opzt.ru
opzt@opzt.ru

Russian rolling stock sector: time to invest



Igor Skok

Head of the Transport Industry Research Department
at Institute of Natural Monopoly Research (IPEM)

Russia's rolling stock manufacturing sector recorded significant growth in the production of primary railway industry products between 2015 and 2017, which translated into improved revenues for the leading companies. Developments in domestic mainline and urban rail markets encouraged local manufacturers to further update and modernise their offers. These improvements have relied on both in-house and imported technical solutions.

Market overview

The Russian rolling stock manufacturing sector holds a prominent position within the global market. Russian manufacturers' overall share is around 6.7% (fig. 1) while the Russian market was worth €8.05bn in 2017.¹

In 2013-2015, the Russian railway industry experienced a sharp downturn in production. The value of the market fell from €10.36bn to €4.88bn, which was followed by a minor recovery in 2016-2017. The Russian exchange crisis in 2014-2015, during which the Rouble weakened against foreign currencies following a sharp decrease in oil prices and the negative impact of western economic sanctions,

was a major contributor to this situation.² Indeed, between 2013 and 2016 the rouble lost virtually half of its value against the dollar. Based on an assumption of a frozen Rouble/Euro exchange rate at 2013 levels, estimated production decreased by 24.4% between 2013 and 2015, while in 2017 rolling stock manufacturing output was worth €12.54bn (fig. 2).

Freight wagons, spare parts and locomotives were responsible for the greatest proportion of overall rolling stock products manufactured in 2017. Rolling stock maintenance and repair services also accounted for a significant share of the market (see Figure 3) owing to Russia's large existing rolling stock fleet, which compares in size to those used on the world's largest rail networks in the United States, Canada, China, and India (Table 1).

Russia's freight wagon fleet consisted of 1,078,200 wagons in 2017, while Russian Railways (RZD) and private operators operated more than 25,000 locomotives. Around 19,500 passenger coaches are used on the network.

Russia's rolling stock manufacturers primarily supply the domestic market with export orders experiencing a consistent decline in recent years. Exports fell gradually from 10.6% of total orders, or €516.4m, in 2015, to 8.7% or €491.6m, in 2016, and 6.8%, or €547m,

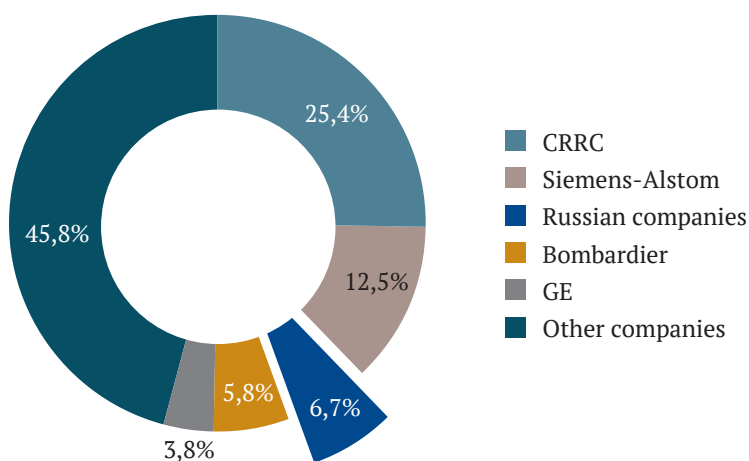

Fig. 1. Breakdown of the international rolling stock manufacturing market in 2017

¹ According to the Central Bank of Russia, the average Ruble-Euro exchange rate was Ruble 66.07:€1 in 2017.

² More information in Railway Equipment, September 2016 (pp. 22-28), August 2017 (pp. 4-9) or at <http://ipem.ru/editions/tzd>

Table 1. Rolling stock fleets of world leading railway systems in 2017

Fleet	Russia	USA	China	Germany	India	Japan	France
Locomotive fleet (thousand units)	25.0	31.0	25.1	6.4	10.0	1.4	3.9
Freight wagon fleet (thousand wagons)	1 078.2	1 340.0	823.0	183.7	244.7	9.4	90.7
Passenger coach fleet (thousand cars)	19.5	6.6	59.8	6.5	54.7	1.1	5.1

in 2017. Exported goods primarily consist of freight wagons and containers (41% of overall exports in 2017), and rolling stock components (36% of orders in 2017) (fig. 4).

Rolling stock manufacturing technologies

The ongoing development of the railway network and traffic management systems requires regular upgrades and modernisation of rolling stock used on the network as well as the introduction of new rail vehicles. To meet these requirements, manufacturers have been required to update their existing manufacturing facilities and build new production sites. From 2013 to 2017, Russian manufacturers invested €760m in modernising their facilities, including by starting production of rail vehicles, components and subsystems at new greenfield manufacturing sites.

Examples of new products and new production sites developed by Russian-based manufacturers include:

- RIC-gauge sleeping coaches and double-deck passenger coaches by Tver Carriage Works,
- ES2G or Lastochka EMUs by Ural Locomotives,
- modern Moskva metro cars by Metrowagonmash JSC,
- 2TE25KM diesel freight locomotives by Bryansk Engineering Plant,
- modern low-floor trams by Tver Carriage Works,
- a greenfield plant to produce traction transformers for locomotives and multiple units by Siemens Transformers, and
- a new plant to produce braking systems for rolling stock by Knorr-Bremse Rail Systems.

Modernisation of manufacturing facilities has involved the installation of advanced process equipment in existing and new pro-

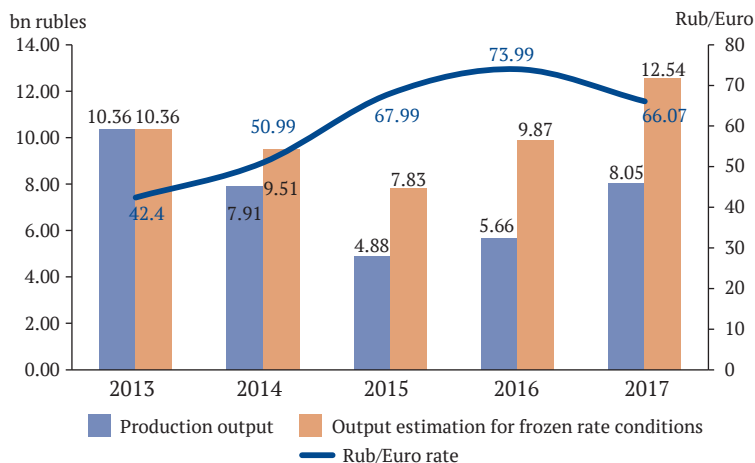

Fig. 2. Rolling stock sector output and average Rouble/Euro exchange rate in 2013-2017

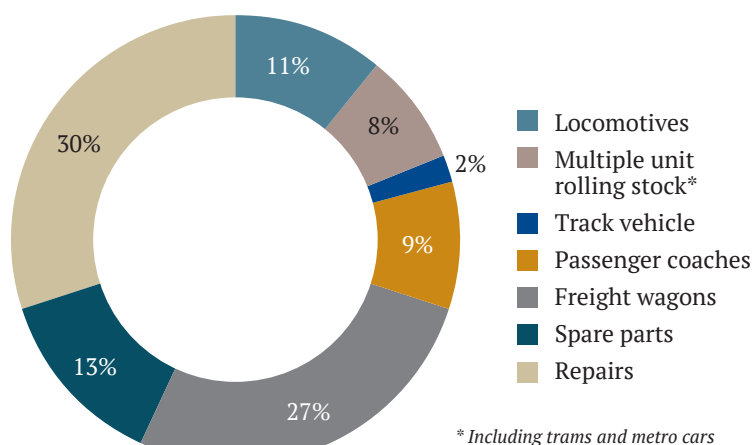

Fig. 3. Russian rolling stock sector breakdown, 2017, mln EUR

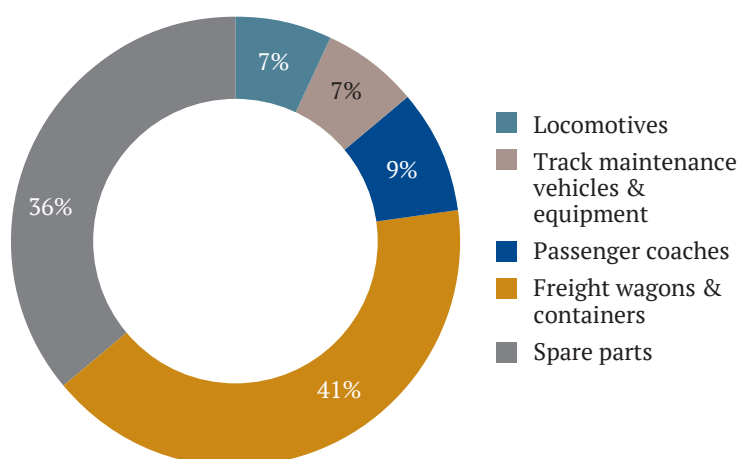

Fig. 4. Breakdown of Russian rolling stock exports by product in 2017, mln EUR

duction lines, including foundry equipment, machining tools and equipment, assembling jigs and benches, and crane and handling facilities. Robot-based operations have been implemented while digital simulations have been introduced to improve testing.

Rolling stock updates and improvements are partially reliant on in-house research and the know-how of individual manufacturers. The Russian railway manufacturing sector spent €140m on research and development between 2013 and 2017. Russian companies have also cooperated extensively with international companies to develop new technologies and have formed several joint ventures which now produce rolling stock and components. Among the world-leading companies now active in the Russian market are Siemens, Alstom, Bombardier, Stadler, General Electric, and Knorr-Bremse.

Cooperation between Russian and international manufacturers is illustrated best in the following projects:

- 2ES10 electric freight locomotive developed by Sinara-Transport Machines (STM) and Siemens. From 2010 to 2017, 151 locomotives have been sold, with contracts valued at €509.9m,
- ES2G Lastochka EMU designed by STM and Siemens. A contract for 1200 cars

A step forward

Despite the invaluable experience gained through international cooperation agreements and the high manufacturing capacity now available in Russia, the rail vehicle building sector still faces a shortage of the state-of-the-art technologies required to produce rolling stock products which meet the demands of the market. This situation became particularly apparent with the economic crisis of 2015 and the deterioration of the global political and economic environment. While it was reasonably affordable for Russia to buy imported rolling stock and components until quite recently, it is now largely economically disadvantageous. Firstly, the weak rouble has increased the price of imported rolling stock. Secondly, political tensions between Russia and an

with RZD is worth €2.1bn with delivery beginning in 2015 and set to run to 2023,

- RIC-gauge passenger coaches built by Transmashholding and Siemens for use on services between Russian and European cities, including Moscow - Paris, Moscow - Nice, and Moscow - Helsinki. These contracts are worth more than €500m with 200 coaches delivered between 2012 and 2014, and
- EP20 dual voltage passenger locomotives developed by Transmashholding and Alstom. 200 locomotives are being delivered from 2011 to 2020 under contracts worth more than €1bn.

As well as rolling stock manufacturing, international companies have developed facilities in Russia to produce subsystems and components, including electrical equipment, braking systems, diesel engines and their sub-components.

The Russian market is also importing some rolling stock products. For example, Spanish manufacturer Talgo has delivered Talgo 250 high-speed passenger coaches which are now in use on services between Moscow and Nizhny Novgorod in Russia, and between Moscow and Berlin. The contract with Talgo was worth €135m.

importing country could result in the partial or even a complete loss of the supply of imported goods both for existing and potential contracts.

To address the situation, the Russian government has introduced an Import-Substitution Programme, which invites foreign rolling stock and components producers to enter the Russian market by localising manufacturing facilities and establishing joint businesses with domestic manufacturers.

In particular, these arrangements could address the following demand in the Russian market for the following rolling stock products and components:

- electronics systems for locomotives and motorised rolling stock (multiple units, light rail vehicles and metro trains),

- energy storage units for rolling stock, including rechargeable batteries, inertial energy-storage devices,
- diesel engines and components for locomotives and DMUs,
- fuel injection equipment,
- telecommunications and data signaling systems,
- electronic components, including resistors, capacitors, transistors,
- very high-speed passenger rolling stock,
- heat-exchange equipment,
- sealing materials suitable for corrosive environments,
- maintenance vehicles for very high-speed lines, and
- subarctic rolling stock.

The evolution of the Russian railway market

Russia's railway network is one of the largest in the world. The total operational length of the railway is 86,000km, including 44,000km of electrified lines, with an overall track length of 124,000km.

In 2017, rail freight turnover amounted to 2344 billion tonne-km, or 86.9% of Russia's total freight traffic, excluding pipelines. Passenger traffic reached 124.6 billion passenger-km, accounting for 24% of total ridership. Railways remain the most convenient means for long-distance freight transport, and rail is the only option for bulk handling of goods such as coal, ore, timber, and construction materials.

Nevertheless, the market demands reliable, safe and efficient rail freight services. To better meet these objectives, a number of initiatives focusing on developing and improving rail's performance have been initiated in Russia:

- RZD's Long-Term Development Programme, which ran until 2025⁵.
- Heavy Traffic Development Programme.
- Eastern Operating Ground Development Programme, which includes the Baikal-Amur Mainline and Trans-Siberian Line.
- Northern Latitudinal Railway Construction Project.
- Moscow – Kazan Very High-Speed Line Construction Project.
- Digital Railway Project, and
- Passenger service development.

The goal of RZD's **Long-Term Development Programme** is to grow rail freight

transport by 1.9% and freight turnover by 2.2% annually. Under the plan, rail should carry 1.604 billion tonnes of freight by 2025, a 16.3% increase compared with 2017, while freight turnover should reach 2789.7 billion tonnes, an increase of 19% compared with 2017. In order to deliver such strong growth, the network will require the introduction of additional rolling stock, including mainline and shunting locomotives and freight wagons. The estimated capital expenditure for this programme is €54.5bn up to 2025.

The Heavy Traffic Development Programme covers improvements to existing infrastructure on several lines and the renewal of rolling stock. This is intended to launch the operation of freight trains on several major heavy traffic lines with an average weight of 7,200 tonnes, with the goal of increasing this to 9,000 tonnes. The programme is targeting improvements on the following lines:

- Kuzbass – Saint Petersburg shunting station.
- Kuzbass – Murmansk.
- Cherepovets – Kostomuksha.
- Cherepovets – Kovdor.
- Cherepovets – Olenegorsk.
- Kuzbass – Sverdlovsk shunting station – Agryz – Moscow – Smolensk.
- Kuzbass – Chelyabinsk – Syzran – Azov Sea/Black Sea ports.
- Aksarayskaya – Volgograd.
- Stojlenskaya – Chugun.
- Zaozernaya – Krasnoyarsk.

⁵ Russian Railways (RZD) is Russian state-owned vertically integrated company which owns public rail infrastructure and a large portion of rolling stock used on the Russian network. It is also Russia's leading rail operator with the company established in 2003 as the successor to the Russian Ministry of the Means of Communication.

Currently more than 21,000km of lines are capable of supporting the operation of trains with enhanced weight and length. A further 13,700km of lines are expected to support heavy-haul operations by 2030.

Heavy-haul freight operations require the use of advanced and more efficient rolling stock, including locomotives and freight wagons. As a result, the programme foresees the switch to enhanced capacity freight wagons, which may be achieved by increasing the axle load from 23.5 tonnes to 25 tonnes initially, and potentially up to 27 tonnes in the future. Freight wagons with a 25-tonne axle load already make up more than 15% of the total freight wagon fleet, while 27-tonne axle load wagons are at the pre-serial stage of development. The locomotive fleet will also require renewal. According to RZD's requirements to enhance its locomotive fleet's technical operating condition to deliver the traction effort necessary to haul a heavy freight train, performance enhancements rather than adding more locomotive sections is the preferred approach. According to the programme, about 100 modern locomotives will be required to support future heavy-haul operation with an investment of €378m envisaged.

The Eastern Operating Ground Development Programme includes construction of 5,100km of track during the initial phase and another 15,500km in the second phase. The overall length of the Russian railway network is expected to increase to between 102,900km and 107,600km by 2030, which is a respective increase of 18% and 24% compared with 2017. This project will create a key transport link that will provide straightforward access to a vast territory of around 1.5 million km², which is rich in valuable crude minerals, fuel, energy and forest resources. It will also provide the shortest inter-continental route between the east and the west, with 10,000km of this increasingly important link set to run on Russian infrastructure. Indeed, the project is set to support a significant increase in both domestic and international rail freight traffic. The first phase of the programme, which will

take place between 2017 and 2019, is estimated to cost €5.01bn.

The Northern Latitudinal Railway is currently in the design stage and envisages the construction of a 707km railway that will run mainly above the Arctic Circle in the Yamalo-Nenets Autonomous District. The start of construction is planned for 2018, with completion expected in 2022. The line is anticipated to carry 23.9million tonnes of freight per annum, comprising mostly liquefied natural gas and petroleum products. Due to the extreme climate in which the railway will operate, a new fleet of locomotives and wagons is expected to be developed. These units will be adapted for effective operation in extremely low temperatures. The estimated cost of the project is €3.57bn.

The Moscow-Kazan very high-speed line project will require the use of rolling stock not previously manufactured in Russia, including state-of-the-art very high-speed trains and track machines. According to preliminary estimates, the new rolling stock is expected to cost €760m. As of June 2018, the total project cost is €23.2bn.

The Digital Railway Project is focusing on the deployment of state-of-the-art digital technologies in order to improve the competitiveness of Russian railway transport. One of projects under development is a Smart Locomotive, which is attempting to introduce the following innovations:

- a microprocessor-based control and diagnostics system with an integrated locomotive safety function;
- a uniform automated train management and information system;
- an asynchronous traction system for locomotives, including independent axle tractive effort control, and
- an efficient system for returning energy to the grid.

Renewal of suburban EMUs and long-distance passenger sleeping coaches is planned as part of the **Passenger Traffic Development Strategy**. If state subsidies are provided, suburban passenger companies are planning to invest €3.45bn on 3000 EMU cars and €3.88bn on 5,900 coaches by 2025.

In addition to these development programmes, it is important to point out the need for timely upgrades and maintenance

of the existing rolling stock fleet, with the sector expected to spend around €8-9bn annually on these activities.

New markets

With exports of rail products and services gradually contracting, at the end of 2016, the President's Council on Strategic Development and Priority Projects accepted the strategic development initiative, International Cooperation and Export, which identifies rolling stock manufacturing as a key focus area for export development. According to the document, export of Russian-manufactured products shall increase by 3.2-times compared with 2017 to about €1bn by 2025.

Russian manufacturers are currently implementing or have recently completed several rolling stock export projects:

- In 2017, United Wagon Company (UWC) signed a contract to deliver 6,000 freight wagons to Iran. An initial batch of 1,100 wagons will be manufactured

in Russia, with the remaining 4,900 wagons assembled at Iranian facilities. The value of the contract has not been disclosed.

- Between 2015 and 2018, Transmashholding overhauled 222 metro cars for Budapest. The trains were originally manufactured and delivered by Mytishchi Car Building Plant, now Metrowagonmash, a subsidiary of Transmashholding. The contract is worth more than €200m.
- From 2014 to 2016, Metrowagonmash delivered 54 DMU cars to Zeleznice Srbije (Serbian Railways). The contract was worth about €25m.
- Between 2018 and 2021, STM will supply 75 shunting locomotives to the Cuban Union of Railways in a contract worth €200m.

Achieving a win-win scenario

Today the Russian rolling stock manufacturing sector is enjoying a period of intense recovery after performance declined following a deterioration in the international political and economic situation. In 2017 production output had rebounded to 2014 levels when foreign exchange effects are taken into account, and exceeded the level of production witnessed in 2013, when the foreign exchange impact is excluded. However, there is still a lot of work to do to secure further sector development.

The Railway Transport Development Package encourages Russian manufacturers to improve their offer to the market and adopt new production technologies. Demand for state-of-the-art rolling stock is expected to grow significantly between 2017 and 2025. However, meeting this demand could prove very challenging without looking to the experience and best practices of the world's

leading companies. Developing rail vehicles and production processes, which are already available off-the-shelf from international rolling stock companies, would require serious investment as well as a significant amount of labour and time, which may adversely affect the schedule and successful implementation of railway transport development programmes. On the other hand, the high potential of the Russian market is a good basis for mutually beneficial cooperation agreements between domestic and international companies and offers significant opportunities to localise production in order to meet current and future demand.

Indeed, the main objective of the International Cooperation and Export project is to support significant growth in the export of Russian products, and is expected to drive a 10% increase in overall production by 2025. 

'Moskva' Metro Train



Alexander Gulyaev,
Chief Design Engineer at TMH
Engineering, Metrowagonmash



Arkady Zaytsev,
Deputy Chief Design Engineer
for metro cars, TMH Engineering,
Metrowagonmash

In 2013, Moscow Metro issued a request tender for the supply of new metro cars and their subsequent maintenance for 30 years. Bidding followed in 2014 with seven manufacturers taking part: Alstom; Hyundai; Škoda; Siemens in partnership with Russian Machines; Uralvagonzavod in consortium with Bombardier; Sinara in consortium with CAF; and Metrowagonmash. Despite Siemens (2013) and the CAF-Sinara consortium (2014) preparing and submitting full-scale mockups of the cars they were offering, Metrowagonmash secured the 1.7bn EUR contract to supply 96 eight-car trains (768 cars in total) in December 2014, with the manufacturer set to supply the trains between 2017 and 2020. Train design was performed by Metrowagonmash's design-engineering office, which has been a separate business unit within TMH Engineering since 2017.

Technical specifications

The customer included several requirements in the tender intended to enhance both the train's safety and passenger comfort. This included open gangways throughout the entire train, wider entrance doors, and improved HVAC systems both in passenger cars and the driver's cabs. Enhanced safety devices include designing the car to better withstand a collision with another vehicle, and improved reliability and performance of passenger information systems and doors.

The new trains are similar to previous trains supplied to the Moscow Metro in that they consist of eight cars and are bi-directional (fig. 1). The main specifications are shown in Table 1.

All of the earlier cars that form trains used on the Moscow metro are motorised. However, the new trains include two intermediate non-motorised cars, which along with savings from the traction system, help to reduce the overall weight of the train by 6%.

A major difference for passengers is the use of a wide, open gangway. All previous trains used in Moscow featured closed cars, with passage to the neighbouring vehicle only possible in an emergency.

The customer requested the chosen manufacturer to widen the passenger entrance doors from 1,250mm to 1,400mm (pic. 1). This was achieved by enlarging the openings in the car bodies and changing the interior layout in the doorway area. The width of the seats on either side of the doors remained the same. The wider doors and the canted shape of the doorway form a passage that narrows towards the exit and make it possible for passengers to pass through the car doors quickly during peak times, helping to reduce the dwell time at stations by more than 10%. Wider doorways and a wider gangway have resulted in a reduction in the design strength, as shown in the digital simulation. The frequency of the car body's natu-

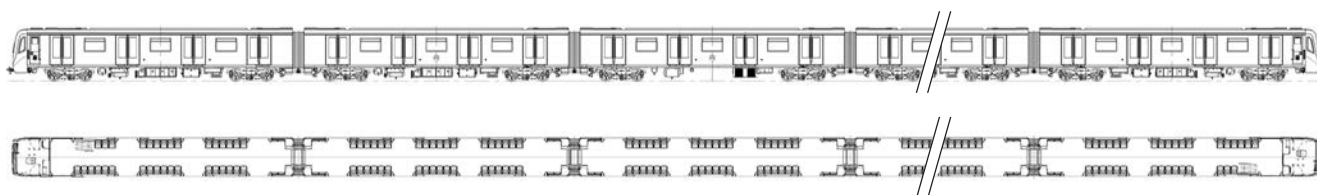

Fig. 1. Moskva train configuration



Pic. 1. Entrance doors and inter-car gangways



Pic. 2. Car interior layout

ral vibration at full capacity are also reduced by 10% and is less than the 8Hz required by Russian standards.

Subsequent modifications of the car body structural layout as well as the introduction of laser welding to the manufacturing process resolved these car body stiffness issues, and also improved the appearance of the flat side wall by reducing thermal deformation in the welding areas.

The new train's passenger car layout is similar to classical solutions where passenger seats are positioned with their backs to the side wall. However, there are some differences. Firstly, there are areas for baby-strollers or wheelchairs in the lead cars. Secondly, there are supports for standing passengers at the end of the cars instead of end seats which provide unhindered access to the inter-car gangways.

During the course of the interior design work, the main task was to develop a sense of spaciousness and elegance for the vehicles. This was achieved by using simple vertical and horizontal geometric design principles, the severe linearity of which is enhanced by the smooth bends used in the doorway handrails, covers above the doors, and the inter-car gangway stands. The interior design focuses on simple forms familiar to the younger generation and uses advanced tablet computers and smartphones. The trains also incorporate USB charging units for use by passengers.

The car is lit by a continuous strip of LED lights, and at the request of the customer, the level of light emitted from the lamps can change on command from the driver's cab. The light can vary from cold and invigorating in the morning to warm and soothing in the evening.

Handrails are positioned so that all adult standing passengers have access while the train is in motion. Moscow Metro required that vertical handrails are mounted in the centre of entrance areas (pic. 2) close to doorways, which has never been done before. However, while these handrails were convenient for standing passengers, they proved a

Table 1. Technical specifications of the Moskva eight-car train

Railway gauge (mm)	1524
Empty weight (tonnes)	278
Length over couplers' heads, mm, max.	155,000
Car width (mm)	2,684
Empty car height above the top of the rail (mm)	3,680
Car floor height above the top of the rail (mm)	1,160
Number of seats	338
Maximum passenger capacity at the rate of 10 prs/m ²	2,604
Maximum axle load (tonnes)	15
Number of doors in each passenger car	8
Design speed (km/h)	90
Maximum acceleration (m/s ²)	1.3
Mean deceleration from 80km/h at electric braking (m/s ² max.)	1.1
Specific power (kW/t)	8.96
Total one-hour rating of traction motors (kW, max.)	4,080
Rated power supply voltage (V)	750
Maximum current consumption (A)	6,500
Power recuperation factor at recuperative braking under condition that the catenary system accepts the recovered energy in full, min.	0.35
Car specific consumption of materials at maximum production workload, max.	1.52
Specified service life (years)	30

major hindrance to passengers entering or leaving the train, reducing the speed of this process by 20% and counteracting the benefits of a wide door. As a result, the vertical handrails were replaced by handles mounted to the ceiling.

In general, the number of handrails in the cars has increased by 30% compared with previous metro trains, significantly enhancing

the convenience for standing passengers. The inter-car gangways are also equipped with handrails allowing passengers to stand in these areas in relative comfort.

There are also changes in the handrails composition with the previous metal rails now supplemented by a polymeric shell, which creates a feeling of a warm handrail due to the heat-insulating layer of plastic.

Key car systems

Each metro car is equipped with two double-axle bogies. The bogies used in the motorised and non-motorised cars differ only in the use of motors and gear boxes. A pneumatic bolster suspension system with height control guarantees a constant car height regardless of the load. In addition, the emergency pressure relief system in the air spring is activated in the event of air leakage or shell rupture of another air spring. This helps to maintain the vertical body position and ensures that the trains stay within the tunnel profile.

Braking is performed by the traction motors with the pneumatic shoe-type brakes only used in emergency and at speeds of 7 km/h or below.

The longitudinal force transmission between the bogie and the car body is similar to that of the previous trains whereby a long rod is connected to the body frame at the same position as the coupler. This helps to localise the longitudinal forces transmitted to the car body from the coupler and bogies while simplifying and reducing the weight of the car body's basic structure.

As far as the traction system is concerned, the in-house design incorporates traction converters based on IGBT as well as asynchronous traction motors. A diagram of the traction drive power circuits used in the motorised car is shown in figure 2.

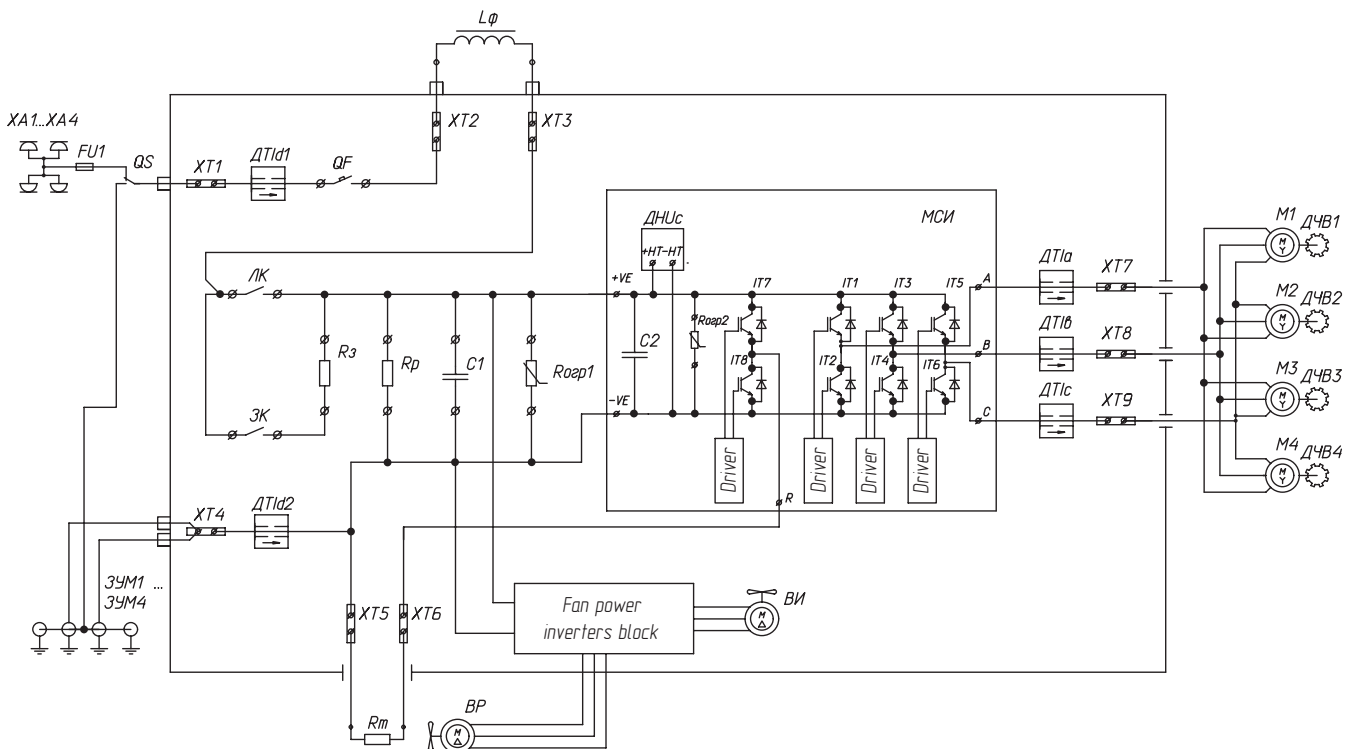

Fig. 2. Diagram of the traction drive power circuits used in a on a 'Moskva' metro train motorised car train

The traction drive's electric equipment set includes a traction converter case, network filter inductor, braking resistor, traction electric motors, and rotational velocity sensors.

In traction mode, power circuit components transform the 750V DC received from the contact rail into a three-phase voltage with adjustable amplitude and frequency for powering the four traction induction motors, which are connected in parallel in each car. The system provides both traction and braking with the traction motors returning about 30% of energy consumed during acceleration following braking.

The new traction motor's design offers a 15% reduction in weight and a 20% increase in traction converter power compared with the previous motor. This system maintains the train's dynamic properties while accommodating two non-motorised cars.

Several potential safety issues received particular attention during the design of the new trains: collision protection; systems to prevent passengers becoming trapped by automatic doors; CCTV monitoring both inside and outside of the train; and a high-quality air supply.

A crash protection system is one of the new technical solutions employed by Moscow Metro. The system was developed according to the requirements of Russian and European reference documents, and regulates the requirements of passive safety systems, which aim to reduce the risks to passengers in the aftermath of collisions. For example, in order to decrease the level of axial force experienced during a potential collision, special cushioning devices were applied to both types of coupling devices installed on the train's lead and intermediate cars.

A Scharfenberg type lead car coupler is fitted with two cushioning devices: one suitable for everyday operations, which can be replaced, and another, which cannot be replaced, which features a cushion length of 250mm for additional absorption of energy in the event of a collision.

For the intermediate permanent couplers, the energy absorption functions are distributed between two coupled devices, with one coupler fitted with a normal operations device, and the other with a collision device. This set up was

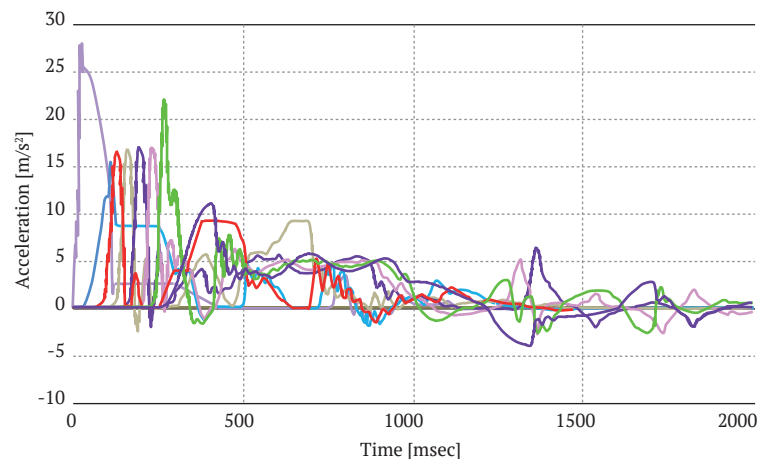

Fig. 3. Correlation between car train acceleration and time

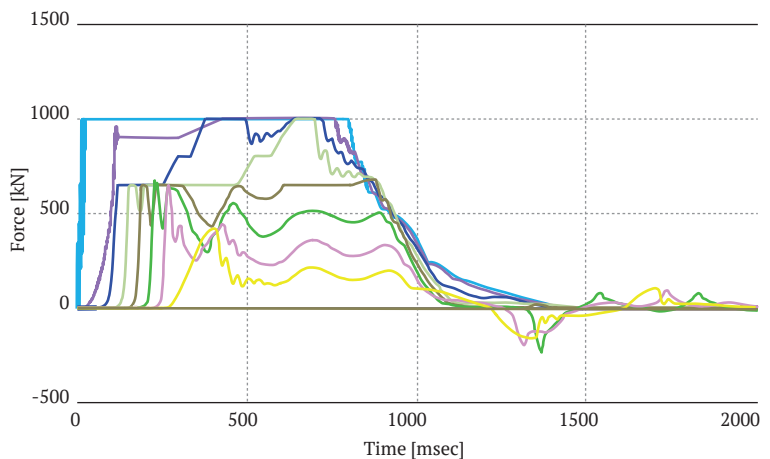
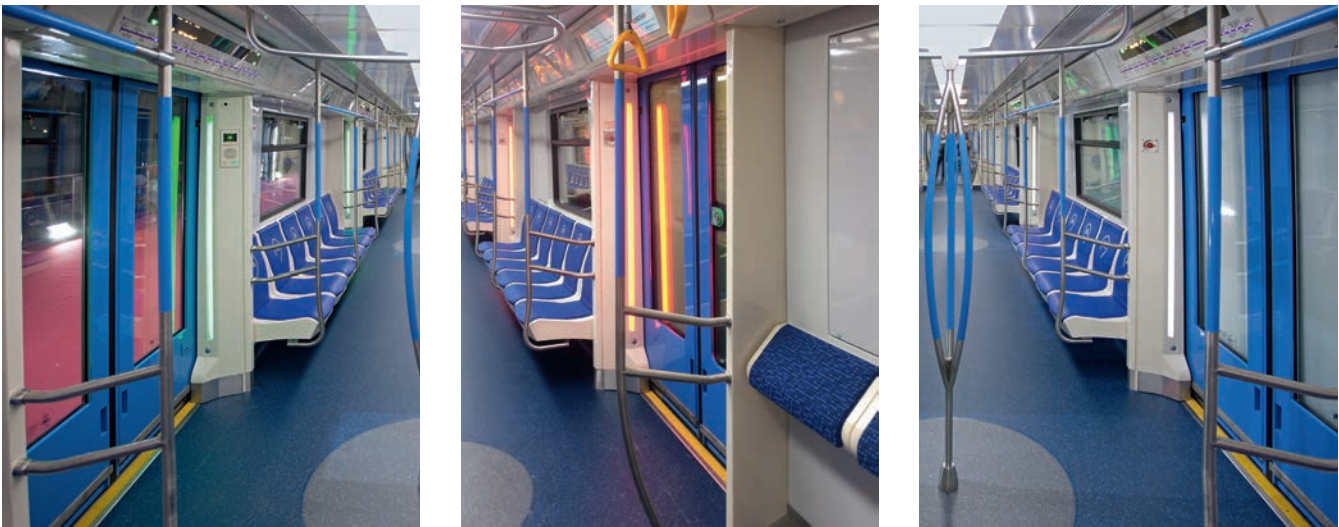

Fig. 4. Correlation between time and force in energy train absorption devices

chosen so that in the event of a collision, the train car's axial accelerations do not exceed 5g while the longitudinal residual deformation of car bodies should not exceed 50mm per each 5m of the carbody. The change in diagonal linear dimensions in doorways and windows should also not exceed 2% of the initial dimensions.

A subsequent numerical study of these device settings proves that the decisions made would produce the desired outcome. It also found that a collision between an eight-car train 50% loaded with passengers with the equal stationary loaded train at 20km/h leads to car acceleration not exceeding 3g, while the maximum force of 1,000kN did not lead to unacceptable carbody deformations. The main characteristics of train impact are shown in figures 3 and 4.

The new car's passenger doors are fitted with light and sound indicators to show when the train is in operation, and also with an an-



Pic. 3. Door indicator lights: the indicator light emits green (on the left), red (in the centre) and white (on the right)

ti-jamming system for occasions when a passenger, ignoring warning signals, finds themselves between two closing doors.

Simple and reliable operation of these indicators is the principal requirement for this equipment. As a result, the primary means of alert for the opening and closing of passenger doors is an LED-diffused light. Using the latest generation of LED lamps minimises operational costs due to their longer service life. The green-red-white light indicators are situated in the doorframe and on the door itself and are clearly visible to passengers, both on the platform and inside the train (pic. 3).

Following the command to close the door, the indicators start to flash red, while at the same time a sound indication is initiated at certain intervals. When the doors are com-

pletely closed, the buzzer switches off, the external horizontal door indicators go out, and the vertical lights in the doorway switch to white to provide additional lighting.

If the passenger fails to pass through the doorway before the doors are closed, or if a foreign object is caught between the doors, an anti-jamming system is activated. The minimum size of an object that will trigger the system is 30x60mm according to European standard EN14752. The maximum force used by doors upon detecting the obstruction is no more than 300N.

Two methods are used to detect objects within a doorway: control of current overload in the door drive's feeding circuit; and control of the door's opening/closing times. The control unit executes constant control of the current level in the electric motor and constantly compares current value with standard values (fig. 5).

If the doors stop due to a jam, the current rises over the standard value and the control unit switches the door control system into jam operating mode. When no confirmation about door closure is received over a given period of time, the control unit also switches the door control system to this mode. The door control system maintains the repetitive cycle of door opening/closing, so that the passengers are able to leave the doorway or remove an obstruction. The motor feed circuit is not aligned until all of the doors are completely closed. If the jam is not removed, the driver and station personnel are alerted.

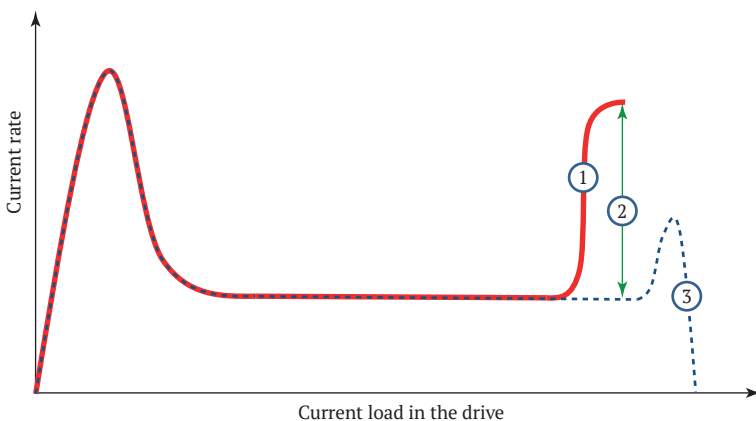

- 1 – real drive current load
- 2 – difference between real drive current and standard current
- 3 – standard drive current load

Fig. 5. Correlation between drive current load and operational time

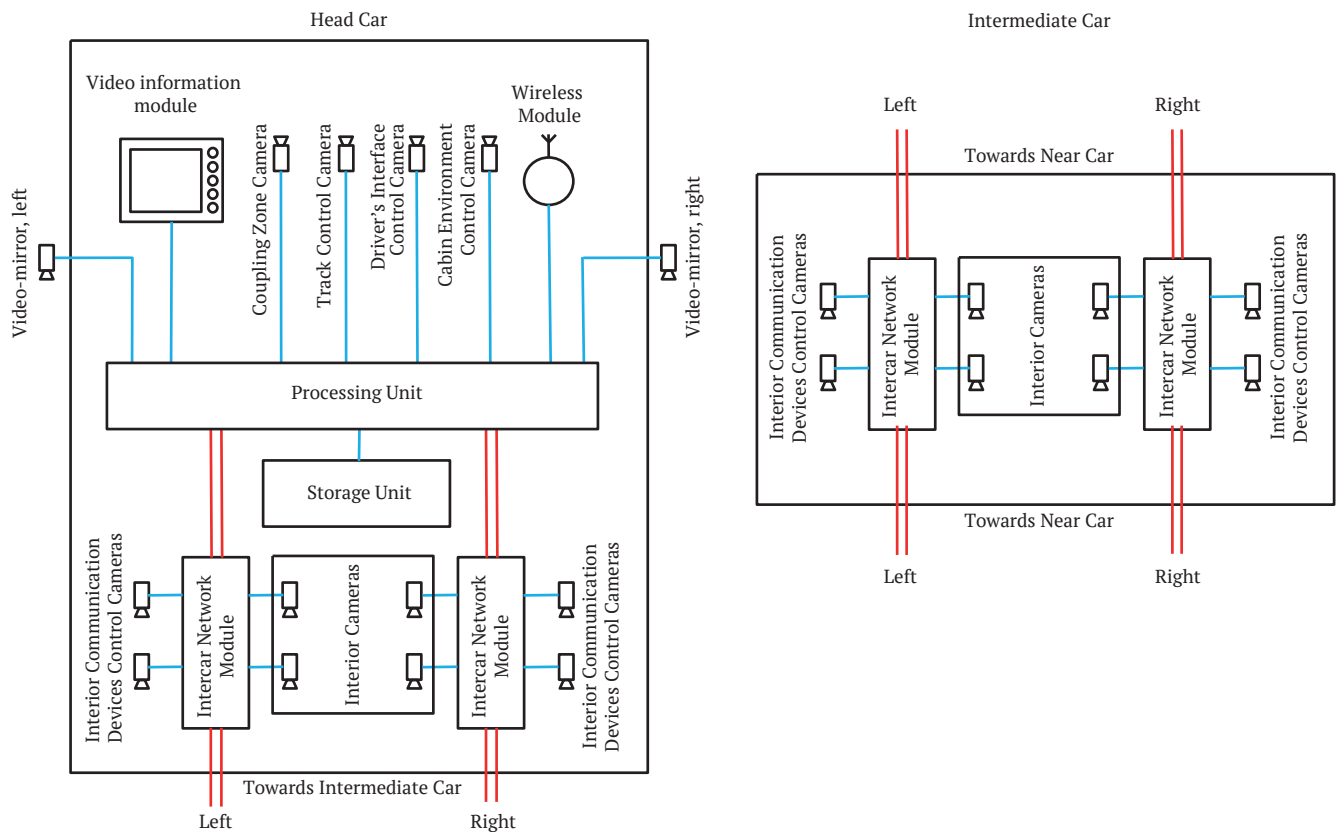

Fig. 6. Structural diagram of the Moskva metro train's video surveillance system

Train safety is achieved through a built-in surveillance system, which operates continuously and uninterrupted until the train's electric equipment is switched off or the battery charge falls below the minimum permitted level.

The video surveillance system only requires manual configuration during commissioning, and in some cases, during preventive maintenance, or when the system is restored after one or several elements have failed. Critically this is not following coupling of the metro cars.

Back-ups are available for the most of the critical elements of the video surveillance system. For example, in the lead cars video registrators are installed, which record events that have taken place. The transfer of surveillance data from the train is conducted using a local Ethernet network. This network incorporates a ring architecture, which guarantees reliability in case of network interruption anywhere in the train. In addition, the video display unit in the driver's cab is also backed up. A structural diagram of the video surveillance system is presented in figure 6.

The system itself consists of an array of video cameras (VCU) situated throughout the train; record units (RU) and information processing units (IPU), which are located in the train's lead cars; a video display unit in the driver's cab (VDU); and video-mirrors (VMU) and other auxiliary blocks and harnesses. Ceiling cameras are installed in every car, while there are also cameras in the dialling unit (DU). A board (VDU block) is installed in the drivers' cab, which enables the driver to select a specific display mode and watch video both from the cars and using the video-mirror systems. The VDU block display also shows diagnostics information and the door jamming status.

The new metro train is fitted with an extensive inter-train communication and passenger communication system (ITCPCS), which supports reliable communication with the centralised Moscow Metro operations centre, where operators evaluate the situation across the network in real-time guaranteeing a fast response in the event of an incident or emergency.

The ITCPCS includes a speaker for various forms of service communication:

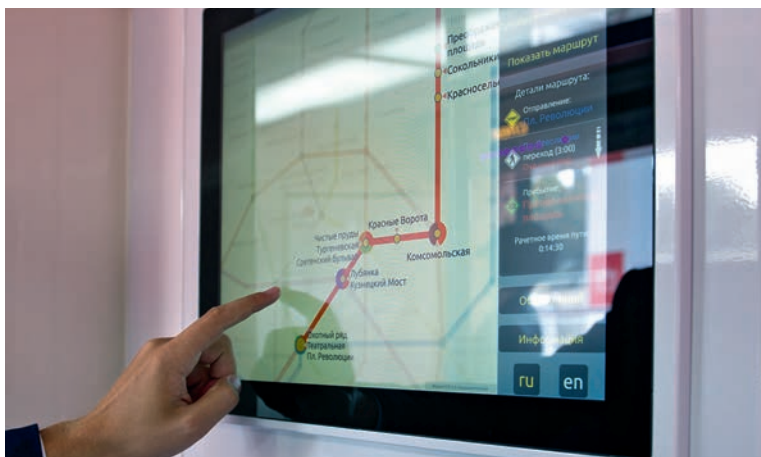

Fig. 4. Interactive panel

- supporting passenger-driver communication and public address from the driver's cab in the event of an emergency
- service communication between the driver's cabs situated at either end of the train
- sound, graphic, and mnemonic information about the train's itinerary as well as emergency, warning and other important safety information
- transmission of informative, social and advertising video content into passenger cars
- control of the executive devices that trigger the car door closing device, and
- recording of messages transmitted via the inter-train communication systems and a connection to facilities that support direct communication with the operations centre.

LED route indicators, installed at the front of the driver's cab, display the route number and the train's destination. An amber LED, which utilises an automatic brightness control, ensures adequate visibility of the display for passengers viewing the display on an underground platform or outdoor track section.

Display panels, installed over every doorway onboard the train, consist of a broadside 12.1-inch LCD display and a speaker. The display shows information about the train's position on the metro network, and previous and upcoming stops.

Passengers can access information about the most efficient route and interchange stations for their journey by using the interactive panels installed in the car walls.

The passenger emergency communication unit is situated in every second doorway of each car. The device provides an audio and

video transmission direct to the control centre, and also enables the driver to transfer a passenger call direct to an operator at the control centre.

Passenger health and well being was taken into close consideration during the design of the ventilation and air conditioning system for the passenger cars and driver's cabs. The system automatically maintains the desired air temperature inside the car with the volume of fresh air supplied set automatically depending on the temperature and the number of passengers in the car, which is determined by load sensors. During station stops, the system switches to a low-noise operating mode, and in case of a sudden interruption to the train power supply from the external network, can enter an emergency ventilation mode with power supplied by batteries.

The ceiling configuration was altered compared with the previous train used on the Moscow metro, enabling the even distribution of air throughout the passenger car after reports that areas at the end of cars and in the air conditioning unit went without an adequate supply of fresh cool air on warm days.

The use of open gangways on the new trains has contributed to improved air flow due to the absence of significant barriers. In addition, the ventilation system developers were mindful of controlling the force of air flow as the train passes through a tunnel. With an area of compressed air forming at the front of the train and a depressurised area forming at the rear, the developers incorporated controlled input and output openings throughout the car which allow air to both enter and leave the train as required. This air exchange system also contributes to a reduction in external noise within the car by creating an additional barrier.

It is widely understood that the presence of a large group of people in a confined space can facilitate the spread of pathogenic germs and viruses, especially during times of the year when exposure is more widespread. In order to minimise the chances of this happening onboard the new metro trains, disinfectant devices have been installed in the ventilation system's air ducts. While in the previous model of the new train, the emitters were only installed in the passenger car air ducts, a similar disinfectant system has also been installed in

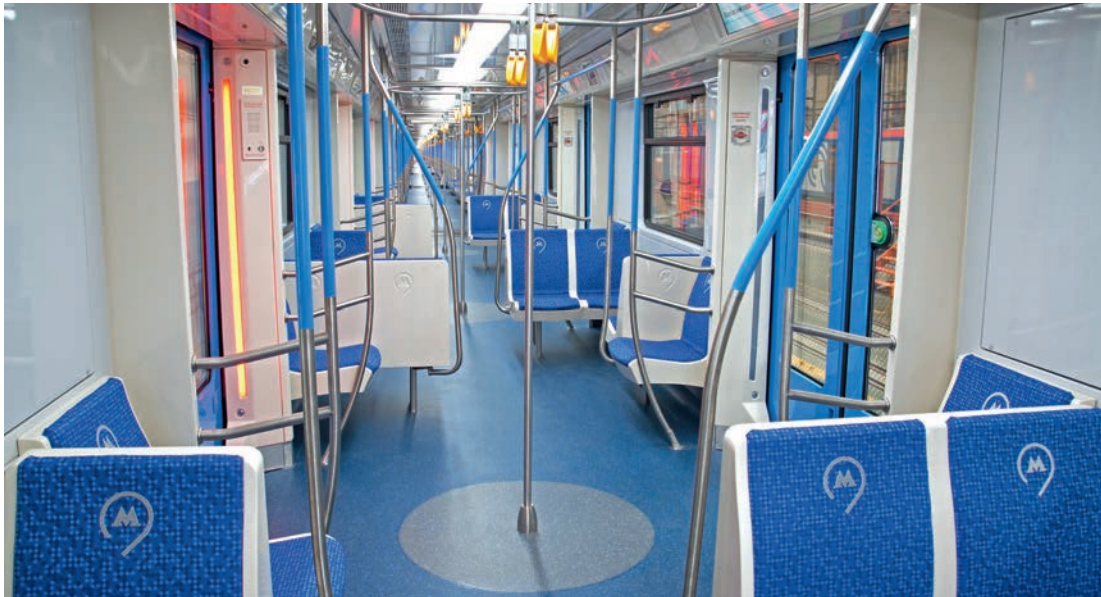

Pic. 5. Interior of the Moskva train for Filevskaya line of Moscow Metro

the air conditioning system used in the driver's cab, which is isolated from the passenger cab.

The train's use of the ALS-ASC signalling system, which includes automatic speed control, guarantees safe operation.

The train receives accurate and appropriate signal commands from rail circuits such as the maximum allowed and safe operating speed and the readiness of the route, informing the driver of the appropriate action to take in the event of an issue. On track sections where a speed limit has been imposed, on receiving the signal, the system will decrease the speed of and ultimately stop the train before the blocked section of track or before a red signal unless the driver confirms that he has seen the speed limit.

Further project development

The Moscow government has extensively evaluated the quality of the supplied trains and subsequently launched a tender for the supply of 27 six-car trains for use on the Moscow Metro's Filevskaya line in May. The requirements for these trains were refined with consideration for the operational experience of the Moskva trains, and the characteristics of this line, which features significant sections in the open air. As a result, the following additional requirements for the fleet was included in the tender: individual push-buttons to open each passenger door; improved performance

The ALS-ASC system display is situated in the lead cars of the metro trains, with the system in the inactive cabin at the rear of the train not participating in train control. The ALS-ASC system utilises two independent but duplicate channels within the train's on-board computer, which guarantees that the algorithm supporting operation as well as the power supply is backed up.

All the features of Moskva Metro train which are described here are well thought out and justified technical solutions - from complicated monitoring and control systems to interior design. This guarantees that rolling stock is not only comfortable and convenient for passengers, but as safe as possible.

of the car floor in winter conditions; and electric heating of driver's footrest and seat.

The most noteworthy feature for passengers is probably changes to the seating arrangement in the lead cars, where some seats will be situated across the car in order to provide seated passengers with an unrestricted view of Moscow through the train's windows (pic. 5).

TMH Engineering, the developer of the new metro trains for Moscow, is certain that this experience will serve the company well in future metro train design projects for Russian and international customers. (S)

Compact messenger cable solutions for high-speed rail lines



Leonid Gurevitch
Head of Department at State
Technical University of Volgograd



Victor Fokin
Director General at Energoservice

Overhead catenary systems installed on high-speed lines possess a number of unique characteristics that ensure safe and smooth train operation. This includes the increased tension of a contact wire, messenger cables and connecting wires; thermal endurance and wear resistance; increased mechanical strength of contact wires and cables; minimal mass of all structural elements but not at the expense of strength and durability; and reliable rust protection. To satisfy these stringent requirements, Ø 120-150mm² low alloy copper or bronze contact wires are traditionally used. The contact wire shall have minimum sag, which is ensured by an overhead catenary system that uses closely spaced droppers to attach the messenger wire or catenary to the contact wire.

Innovative MK-series messenger wire

Russian engineers have created a wire that is ideally suited for batch production while offering high strength, slight temperature-related linear deformation, good rust resistance, electrical conductivity which is close to copper conductors, and enhanced aerodynamic properties. The wires have standard dimensions and are compatible with standard fittings. MK-series compact and plastically-deformed messenger wires may also be used as auxiliary messenger wires, electric connectors between contact wire and feeder line wires.

This copper catenary alloy-free wire solution is a breakthrough in that it offers high strength without the traditional drawbacks of alloy-based solutions. Advantages include:

- reduced amplitude and strength of wire dancing;
- reduced risk of wire break;
- low stress in the event of snow and ice accumulation due to the smooth exterior shape;
- high-strength parameters which are close to the performance of bronze wires;
- high current-carrying capacity and electrical conductivity, and;
- enhanced aerodynamic parameters.

Russian Railways (RZD) and the Russian R&D Institute of Rail Transport (VNIIZhT) have conducted comprehensive tests of the MK compacted copper messenger wire, which demonstrated that pressed wires provide an enhanced cross-section utilisation

ratio, reduced electric impedance in the traction network, improved load-carrying capacity and better thermal resistance. An extensive testing programme checked the factors which may affect the catenary wire in real life but at the possible extremes of performance. This included a thermal degradation check with heating to 155°C, track resistance tests, bending tests, low-temperature creeping tests, endurance to vertical oscillations (eolian vibration) with multiple heating to 100°C, and other tests, some of which have never been performed for catenary wires before.

As part of RZD's Resource-Saving Technologies Deployment Programme, the MK-120 series compacted wire was installed as pilot messenger wire in 2015 and 2016 on track sections totalling 60km on the West Siberian Railway and South Urals Railway. The MK-120 wires were installed according to a traditional installation process using existing fittings and tools and the tests showed that the wire's catenary impedance reduction would offer an economic benefit to the railway.

Following a meeting of the Innovative Technologies Working Group of the Russian Ministry of Transport in September 2016, it was recommended that state-owned companies purchase MK-series messenger wires. In 2017, the MK-120 compacted wires were installed on sections of the Sverdlovsk Railway, South Urals Railway and West Siberian Railway for a total length of 109.4km.

The remainder of this article describes the results of the efforts to optimise the design of these plastically pressed copper-clad steel messenger and contact wires through finite element design methods with the goal of acquiring the required tensile strength at given dimensions.

Plastic deformation of a system consisting of elements with vastly different mechanical properties were based on the careful and correct identification of methods to achieve optimal geometry, design and process-dependent analyses of wire strands as well

as their related technological parameters. This is important as the resulting deformation of the elements may be either excessive or not appear at all. Using traditional empirical methods to change to new wire sizes and testing the prototype wire's strength parameters is both a time consuming and resource-intensive process. Using computer-based simulations of wire pressing and their tensile behavior was therefore considered appropriate for the preliminary capturing of performance data relating to advanced design of the alternative wire.

Methods of research

A wire featuring a central steel core and three copper layers (see case A in Table 1) of 1+7+7/7+14 configuration with an outside diameter of about 14mm was used as a reference case. Plastic deformation simulation was carried out with the use of SIM-

ULIA/Abaqus software suit. The plastic deformation simulation included pulling the stranded wire system through four pressing rollers. Following the pressing process, clamping jaws at wire ends were moved apart at 2 mm/s with resulting force tracing.

Table 1. Configurations of copper-covered steel wires used in simulations

Case	Strand dimension and material				Copper/steel area
	Core	1 st layer	2 nd layer	3 rd layer	
A Non-pressed	Steel 1× \varnothing 29mm	Copper 7× \varnothing 21mm	Copper 7× \varnothing 2.05mm+7 \varnothing 1.45	Copper 14× \varnothing 2.55mm	130.4/6.61mm ²
B pressed	Steel 1× \varnothing 2.9mm	Copper 7× \varnothing 2.1mm	Copper 7× \varnothing 2.05mm+7 \varnothing 1.45	Copper 14× \varnothing 2.55mm	130.4/6.61mm ²
C pressed	Steel 3× \varnothing 2.0mm	Copper 6× \varnothing 2.1mm	Copper 14× \varnothing 1.8mm	Copper 14× \varnothing 2.55 mm	127.9/9.42mm ²
D pressed	Copper 1× \varnothing 2.9mm	Copper 4× \varnothing 2.15mm Steel 3× \varnothing 2.15mm	Copper 7× \varnothing 2.05mm 7× \varnothing 1.63mm	Copper 14× \varnothing 2.65mm	136.1/10.89mm ²
E pressed	Steel 1× \varnothing 2.9mm	Copper 4× \varnothing 2.15mm Steel 3× \varnothing 2.15mm	Copper 7× \varnothing 2.05mm 3× \varnothing 1.63mm	Copper 14× \varnothing 2.65mm	129.4/17.5mm ²

Results and findings

When tension is applied to a wire that is plastically pressed, the major load is carried by the central steel wire (see fig. 1). Copper wire tension causes pitch extension while at the same time the stresses grow slower. Copper wire's contribution to overall strength characteristics is therefore rather small. Following a steel core rupture at ca 25kN, the copper layers undertake a major load but cannot ensure the required breaking force (about 70kN) without the steel element.

Wire plastic pressing (see case B) has slightly improved the performance of core steel wire and stranded copper wires due to friction forces. However, the solution does not offer more than a 30kN strength improvement (fig. 1, curve 2).

For case C, the steel and copper system included three core stranded steel wires with a smaller diameter instead of one steel element, with the steel wire's pitch coinciding with copper wire's pitch. This configuration helped to increase the break-

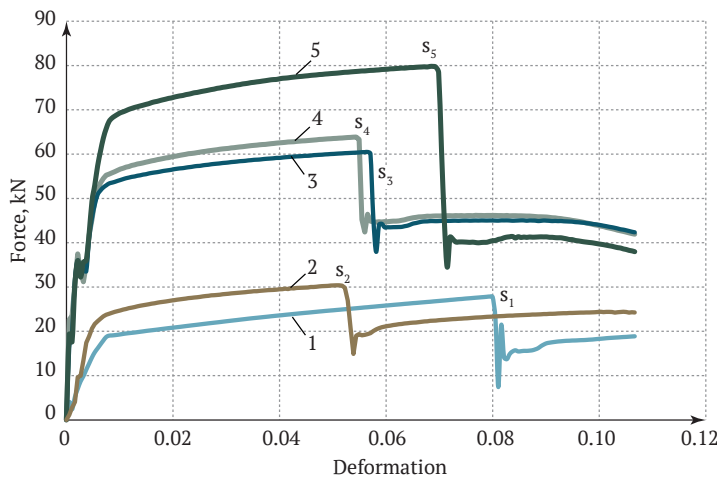

Legend: Sn – steel core breaking point for cases A through D

Fig. 1. Tensile breaking loads applied to copper-clad steel wire. Curves 1 to 5 refer to A to D cases respectively

ing tension to 60kN (see Figure 1, curve 3) without changing the ratio between the steel and copper layer cross sections.

The best breaking tension results were received in case E, which comprised one core steel wire and three steel wires in first layer. The configuration led to a slight reduction of the copper wire’s cross section (see Table 1), but the estimated breaking tension value reached as much as 80kN.

According to the results from the E case during the tests carried out by VNIIZhT, the breaking tension of the $\varnothing 14$ mm plastically-pressed copper-clad steel catenary wires was even better at 80.6kN. The

design and manufacturing process of the catenary wire and its modifications are covered by German and Russian patents.

It is noteworthy that the MK wires have substantially better tensile strength and continuous current performance than messenger wires of a comparable diameter under DIN 48201 (Table 2).

MK wires’ high performance characteristics offer significant opportunities for application not only in Russia but around the world. In order to reach the standards required for international applications, work was initiated at the International Electrotechnical Commission (IEC). In 2015, the TC 9 Dashboard of the IEC General Assembly decided to create a working group to prepare the relevant standards, a unique case for a Russian initiative supported by the IEC. In addition, the initiative was backed by experts from 10 countries, including Germany and Japan.

The preliminary Working Group AHG 14, which drafted the content for the standards, was transformed into permanent Working Group PT 63190 on March 20th, 2018. The working group will develop the standard, fulfil the technical element and secure consensus-based approval by integrating the comments and requirements of the members. The working group’s membership has since grown with the addition of French and British experts .

Contacts:

<http://www.energoservice.com>

e-mail: energoservice2@yandex.ru

Table 2. Comparison of MK copper messenger wire, two copper clad steel messenger wires (MK-HS-1 and MK-HS-4) and bronze catenary wires under DIN 48201

Rated area (mm ²)	Actual cross-section area (mm ²)	Diameter (mm)	Weight (kg/km)	Breaking tension (kN)			Continuous current, A		
				Bz I	Bz II	Bz III	Bz I	Bz II	Bz III
70 DIN	65.81	10.5	596	32.51	38.64	44.14	285	245	175
MK 70	83.4	10.7	780	32.94			366*		
MK70-HS-1	83.4	10.7	774		35.3			347	
MK70-HS-4	83.4	10.7	766			44.2			343
120 DIN	116.99	14	1,060	56.68	67.57	77.46	410	350	250
MK 120	138.7	14	1,300	55.6*			511*		
MK120-HS-1	138.7	14	1,281		69.56			501	
MK120-HS-4	138.7	14	1,108			80.6			473
150 DIN	147.11	15.8	1,337	72.67	86.37	98.67	470	410	290
MK150	182.2	15.8	1,690	72.26			612*		
MK150-HS-1	182.2	15.8	1,678.3		78.6			577	
MK150-HS-4	182.2	15.8	1,658			97.8			572

* Assumptions for current calculation: air temperature 35°C, wire temperature 70°C, crosswind – 0.6m/s

Advertising



LocoTech Group develops and implements Smart Locomotive system. This is a data mining project that allows assessing a technical state of the locomotive, predicting failures and real-time monitoring of operation.

| Clover PMM

Operation monitoring and forecast of the technical state by means of data mining

| 260

The system analyses 260 parameters for 2TE116U and 3TE116U diesel locomotives

| 308

The system analyses 308 parameters for TEP70U and TEP70BS diesel locomotives

| 60

The system can find 60 types of violations in equipment operation and locomotive operation modes

Technology features:

- Determining a probability of equipment unit failures and forecast of equipment failure during the next 100 hours
- Calculation of the unit residual life
- Detection of pre-failure states in equipment operation
- Detection of violations of equipment operating modes

It solves the following tasks:

- Reduction of costs for unplanned repairs
- Improving quality of repairs by using systems of new generation
- Transformation of resource management models (supply, personnel)
- Improving efficiency of equipment operation control

LocoTech LLC is the largest in Russia and Europe locomotive maintenance and repair service group. The Group includes companies that provide full service, repair and upgrade of traction rolling stock according to the life-cycle contract system, leasing of locomotives, manufacturing of units and parts for companies of the heavy equipment industry.

10 locomotive repair plants

about 90 locomotive service depots

2/3 of all RZD OJSC locomotive fleet is served by LocoTech Group

+7 499 638 2298
info@locotech.ru

www.locotech.ru

How can machine learning and BigData benefit locomotive transmission diagnostics?

Igor Lakin

PhD, Prof., director of locomotive technical state monitoring department at LocoTech

Vitaly Pavlov

Dr., mathematics, and developer at Clover Group

Victor Melnikov

postgraduate student with a specialty in EMU and Locomotives at Russian University of Transport (RUT)

The opportunity to use data from a locomotive's onboard microprocessor control system (MCU) to perform diagnostic tasks has been discussed ever since the first MCU-equipped locomotives became available. TMH-Service's Maksim Gorky division initiated MCU data reading and manual transcription in the autumn of 2012, and in the summer of 2013 presented its first automatic workplace applications (AWA), which are offering semi-automatic diagnostic tasks using previously-developed diagnostic algorithms. On the back of this initial success, LocoTech's Smart Locomotive project has set an ambitious task to automate not only MCU data development, but the whole diagnostic algorithm development process. By applying BigData and Machine Learning methods, the team working on the project is aiming to improve diagnostics objectivity by replacing the judgement of human engineers with statistically-proven patterns, which are normally invisible to the human eye.

Locomotive onboard microprocessor systems

Modern locomotives are equipped with onboard microprocessor systems (MCU), which are designed to control the locomotives' electric transmission and secondary appliances. A regular locomotive MCU consists of controller unit, sensors, governing devices (relay and servomotors) and a display module (DM) for interacting with the driver (fig. 1). In addition to providing primary functionality, most MCU's are designed to collect locomotive equipment operating data, which it can store and make available for download using a portable flash-drive, or wirelessly via GPRS or Wi-Fi, depending on the MCU's design.

Since 2012, engineers at LocoTech-Service's locomotive depots (SLD) have read and transcribed MCU data as part of the locomotive technical monitoring process¹. MCU data transcripts identify incidents², which are divided into exploitation mode violations (NRE) and near-failure conditions and are recorded

into the depot's ERP-system (TU-28E) for further review ahead of the appropriate action during the locomotive's next service³. This new approach to monitoring is estimated to have saved Roubles 100m in 2016.

The main drawback of this system is that the quality of incident reporting is strictly dependent on the competence of the engineers carrying out the processes at the depot. To reduce this impact, work began in 2012 to develop an automated workplace diagnostics system (AWA MCU), which has an inbuilt automatic incident search function that uses preset diagnostic algorithms. This initial research led to the creation of an "Oscillograph-3" AWA for 2(3)TE116U, TEP70BS(U), 2TE70, 2(3)TE10MK and TEM18DM diesel locomotives, and MCUD AWA for E5K, 2(3) S5K, EP1M(P), 2(3)ES4K and EP2K electric locomotives. These processes have partially automated the manual work of engineers and

¹ K. Lipa, V. Grinenko, S. Lyangasov, I. Lakin et al. Locomotive technical state monitoring according to onboard microprocessor control systems data. – M.: TMH-Service LLC, 2013. – 156 p.

² In this case, term of "Incident" has been taken from ITIL international standard, where it means any operation mode different from normal exploitation.

³ K. Lipa, A. Belinskiy, V. Pustovoy et al. Locomotive life cycle management in Locotech group. Theory and practice. – M.: LocoTech LLC, 2017 – 212 p.

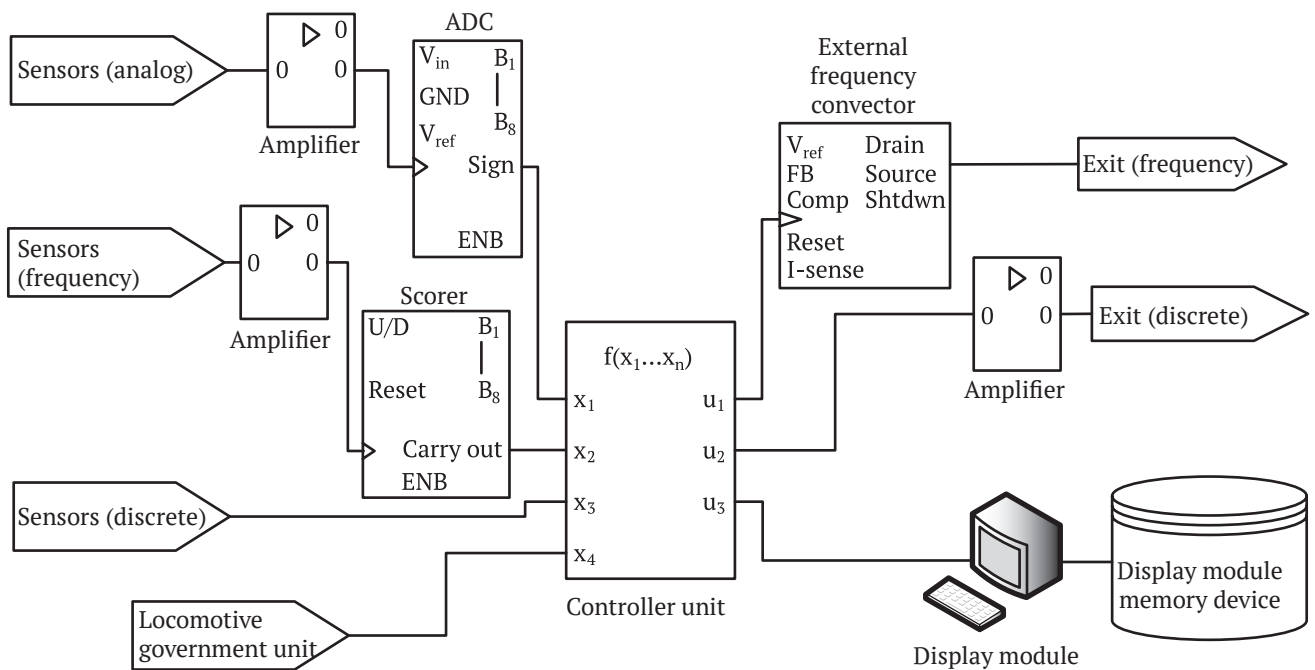

Fig. 1. A basic MCU design

are helping to increase objectivity during monitoring.

However, there is still a major disadvantage of built-in AWA MCU algorithms: introducing any new algorithms would require a reworking of AWA MCU itself. Trials found that introducing new algorithms in order to discover new NRE and near-failure conditions decreased the performance of previous algorithms, meaning that the problems associated with manual incident searching reappeared. The latest version of the MCUD AWA partially solved this problem by utilizing a built-in diagnostic algorithm code writing utility. However, custom

diagnostic algorithms were still present in the local version of AWA and could not be eliminated from every locomotive.

Developments in computer engineering have led to the creation of new data processing methods such as machine learning and BigData, where algorithms are developed especially for highly-efficient processing of huge amount of data. These techniques have not only helped to identify the previously-hidden relationship between changes in data patterns and statistical processing of historical data, but are determining the impact of the mutual influences between parameters.

“Smart locomotive” project

In 2016, LocoTech, in association with Clover Group, initiated the “Smart Locomotive” (SL) project with the goal of analyzing locomotive MCU data using BigData methods. The goal was to discover the little-known relationships between equipment operating parameters, and to determine any trends in the changes that take place which could inform technical condition forecasts. For the pilot, 2TE116IU and 3TE116U DPU locomotives were chosen due to their widespread use, the availability of significant diagnostic data sets, and the considerable existing diagnostic experience

with these particular units. The experiment was subsequently extended to 2TE25KM and TEP70BS units. Within this framework, locomotive MCU data was read by depot engineers and imported to a server loaded with specially-designed MCU AWA. To retrieve the maximum amount of data from the monitoring system, researchers worked with MCU developers including VNIKTI, which had developed ASK systems for 2(3)TE116U, 2TE25A(AM,KM) and TEP70BS DPU locomotives; and LES, which had developed BRPD systems for 2(3,4)ES5K, 2(3)ES4K and EP2K EPU units.

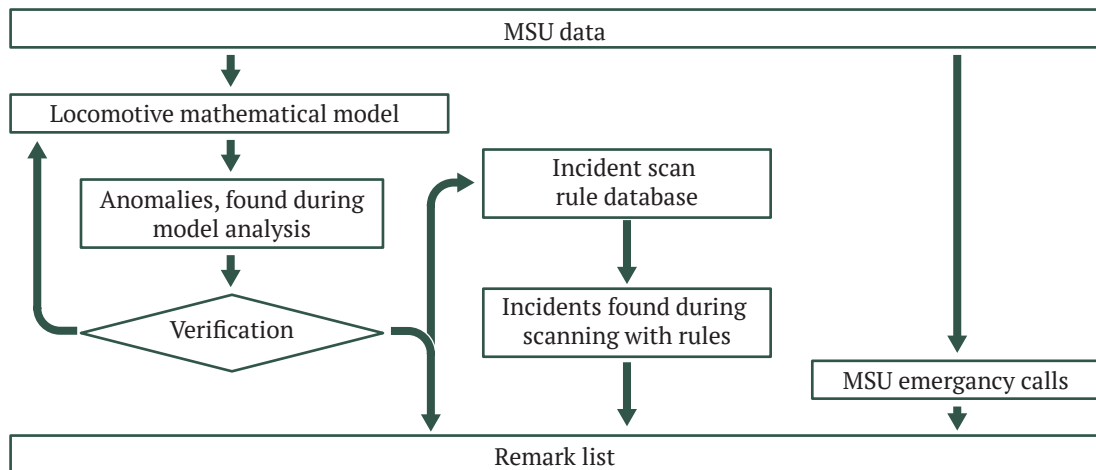

Fig. 2. The MCU data processing model used in the Smart Locomotive project

The SL server performs primary data analysis using the diagnostic algorithms and conduct data comparison with readings received from mathematical models applied under the same conditions (fig. 2). Each real data deviation from the mathematical model's reading is considered an anomaly – an operation mode that has never been seen before. Using diagnostic algorithms is a necessary element of the engineer's work to facilitate and segregate incidents from normal operation. Similarly, any mathematical model anomalies are sent to an engineer for verification. If the engineer confirms that the anomaly is an incident, they confirm the incident type and specify the faulty equipment or component and send the anomaly for further verification by an expert. If this is unsuccessful, the anomaly is specified as a normal operation mode.

Any incidents found during data analysis are included in a locomotive comment list. After SL integration with TU-28E via an organized data exchange, incidents are sent to TU-

28E automatically, and following any repair that is carried out, this action and any equipment replaced is imported from the TU-28E to SL to adjust the equipment model. The equipment model is also designed to exclude the influence of any data received before repair after such an event occurs.

Preliminary research has shown, that for all its robustness, ML-methods have some specific information requirements which must be followed:

1. Information must be continuous for a long period of time. For accurate data flow, there must be no periods where data is missing.
2. The analyzed parameters must be carefully selected and encompass both ingoing and outgoing data. The model is specified as a black box, meaning that ingoing must affect outgoings only through specified a unit.
3. Unimodality of a specified process. In the event that several processes occur in the same unit, it must be divided into several models.

Traction motor functioning analysis

Traction motors were chosen as a priority object for modeling because they meet several selection criteria:

- traction motors are one of the most expensive locomotive equipment components;
- traction motors have high failure rate – in 2016 20% of unplanned repairs (NR) of the test locomotive group were caused by motor failures. Accurate motor diagnostics

therefore represents a major commercial interest for service companies;

- traction motors have sufficient sensors;
- traction motor specification is described in detail both in technical documents and scientific studies.

To ensure fairness, a traction motor based on MCU parameters was built in three different models:

1. Electric model, where there is a relationship between the motor's current and voltage.
2. Electric-mechanical model, where there is a relationship between the motor's current and wheel speed (Table 1).
3. Dynamic braking model, where there is a relationship between wheel speed and motor voltage during dynamic braking.

Models (1) and (2) were combined in a specific experiment.

With the available data unable to meet requirements to develop a control model, even after inserting the ASK and BRPD data, further data preparation was performed to provide the required accuracy:

- Motor operation modes were split on the basis of field weakening. In addition, a dynamic brake application attribute - "Brake switch lock "braking" position" parameter as shown in Table 1 – was applied to separate traction and dynamic braking modes.

Traction contactor attributes ("Motor #1 traction contactor" in Table 1); motor switches ("Motor switch #1" in Table 1); and fuses ("Rectifier fuse #1" in Table 1) were also used

Table 1. Traction motor #1 of 2(3)TE116U DPU electric model

Ingoing parameter	Outgoing parameter
Rectified voltage of 1st rectifier branch	Traction motor #1 current
Field weakening relay stage 1	empty
Field weakening relay stage 2	
Brake switch lock "traction" position	
Brake switch lock "braking" position	
Motor #1 traction contactor	
Motor switch #1	
Rectifier fuse #1	

to distinguish the operation modes in which the traction motors were switched off.

To identify possible jamming, additional screenings for data sections were performed 120 seconds after changing the throttle position and three seconds after fans were switched on or off. All sections contained an active braking pump.

For the MCU, a data model comparison is performed on a similar principle.

Analysis of the electric and electro-mechanical traction motor models show major differences in wheel speed and motor current

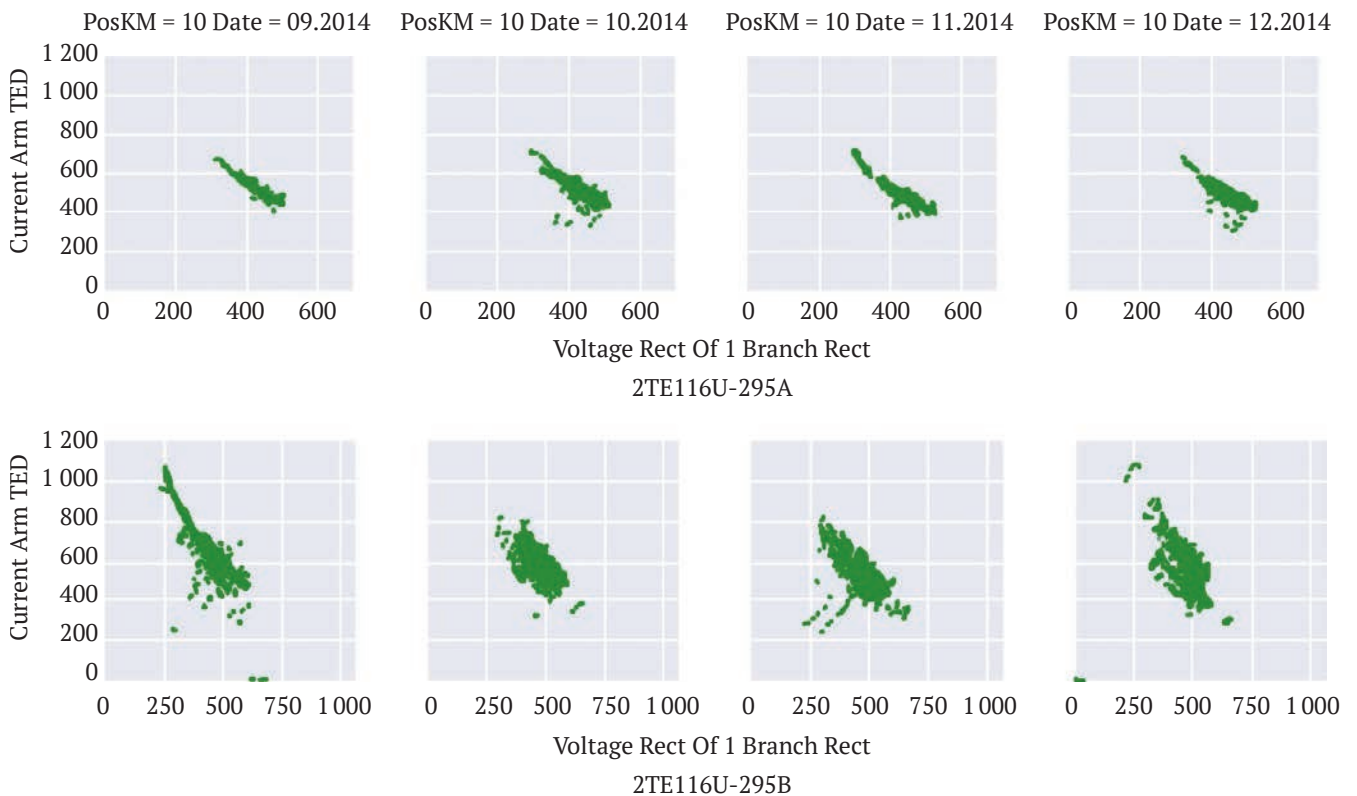

Fig. 3. The relationship between traction motor 2's current and voltage for units A and B of 2TE116U locomotive for four months of 2014

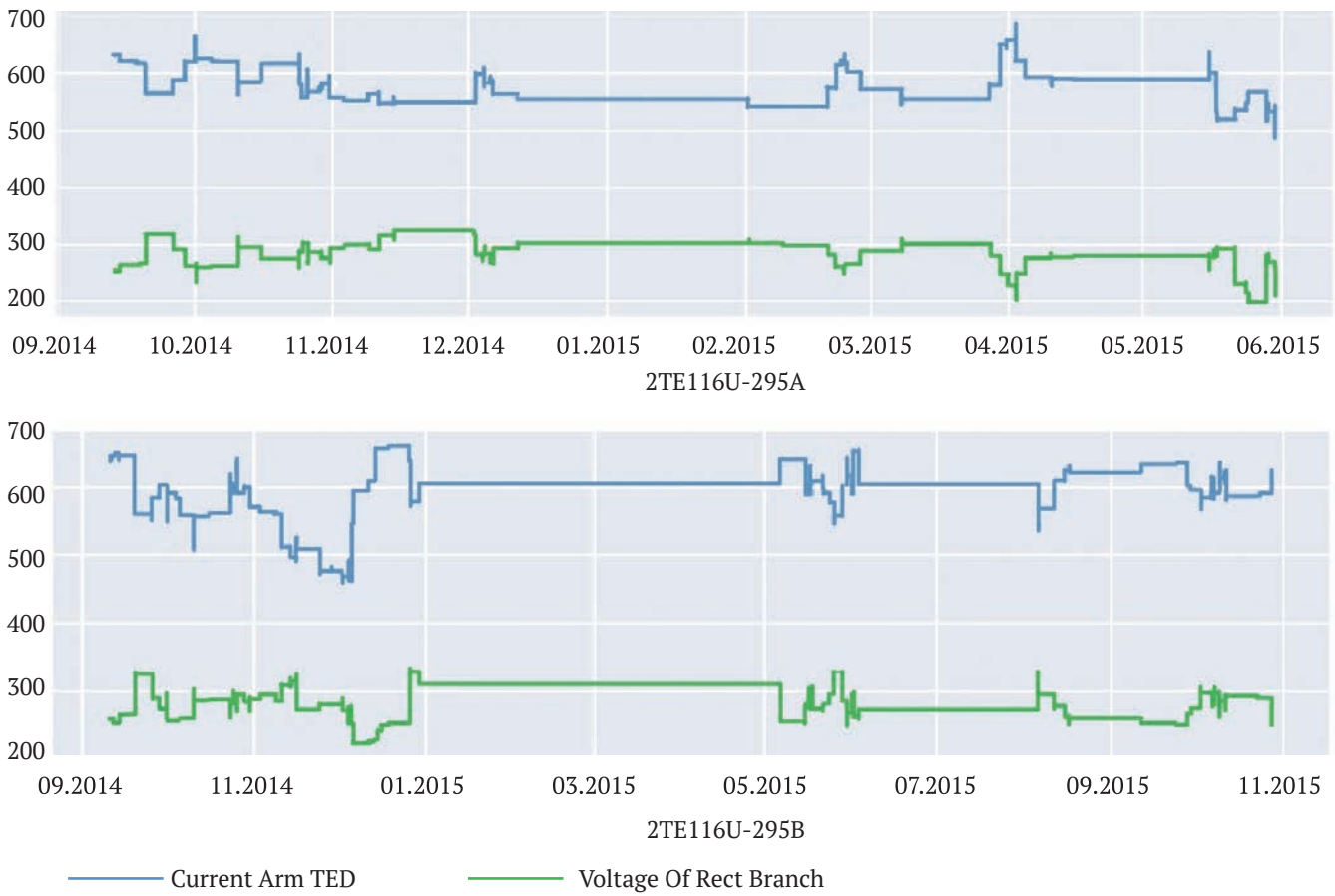

Fig. 4. Variations in traction motor 2's currents and voltages for A and B units of 2TE116U #295 locomotives for 2014-2015

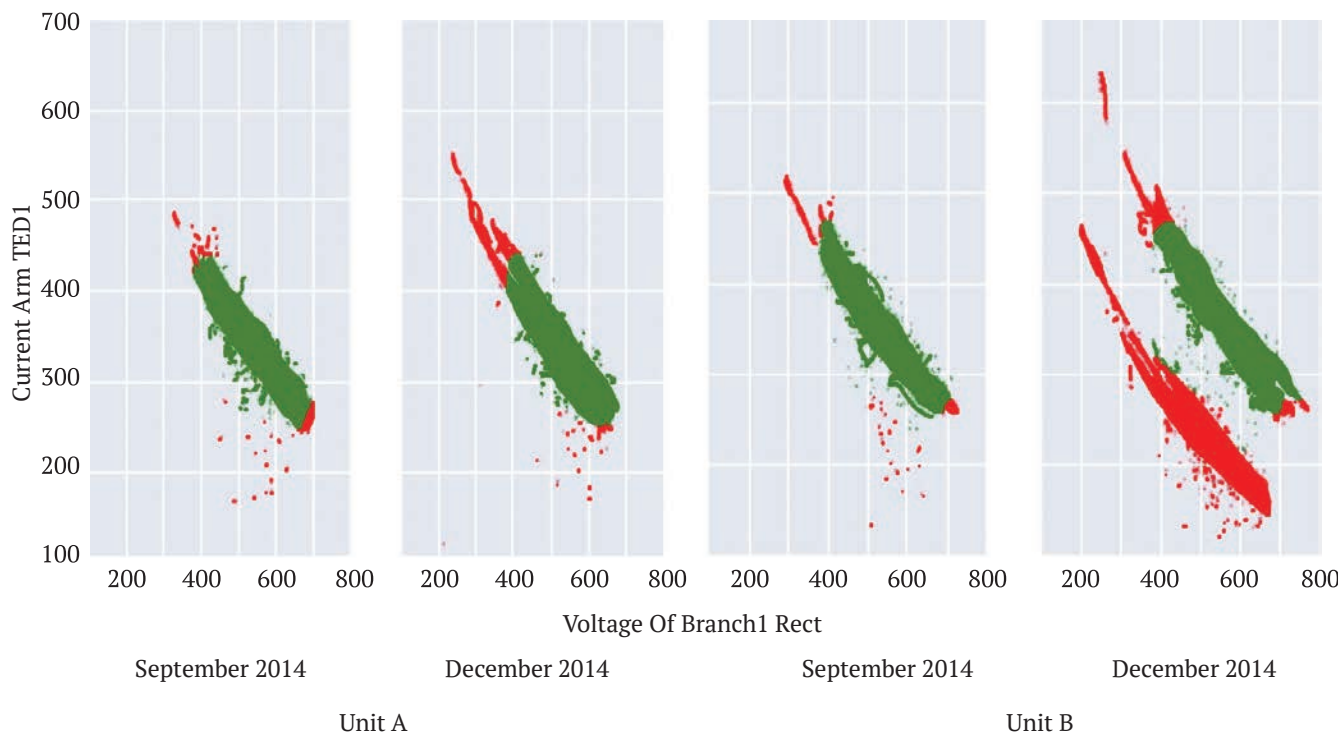

Fig. 5. Traction motor 1 current and voltage interrelations for locomotive 2TE116U #295 in 12 controller positions from September 2014 to June 2015

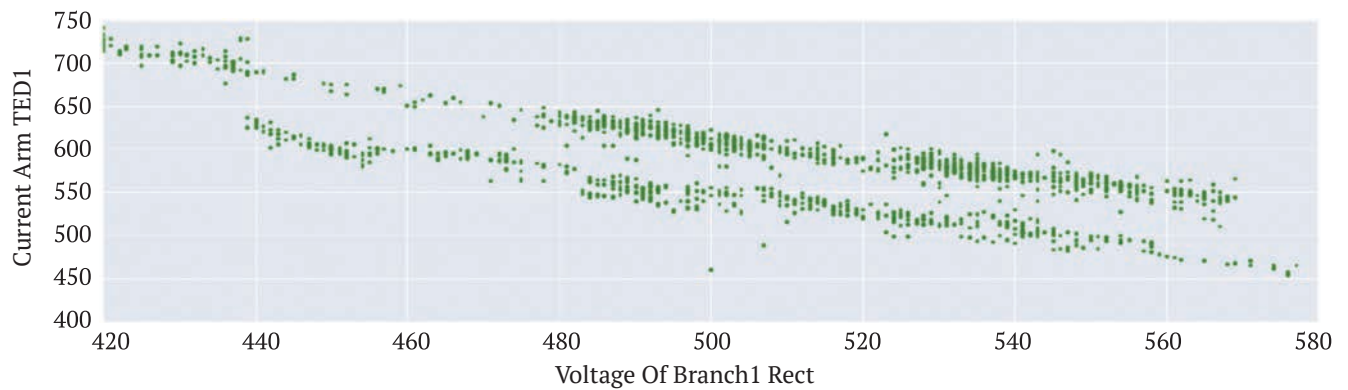

Fig. 6. The traction motor current and voltage relationship for locomotive 2TE116U #240 unit B from January to June 2017

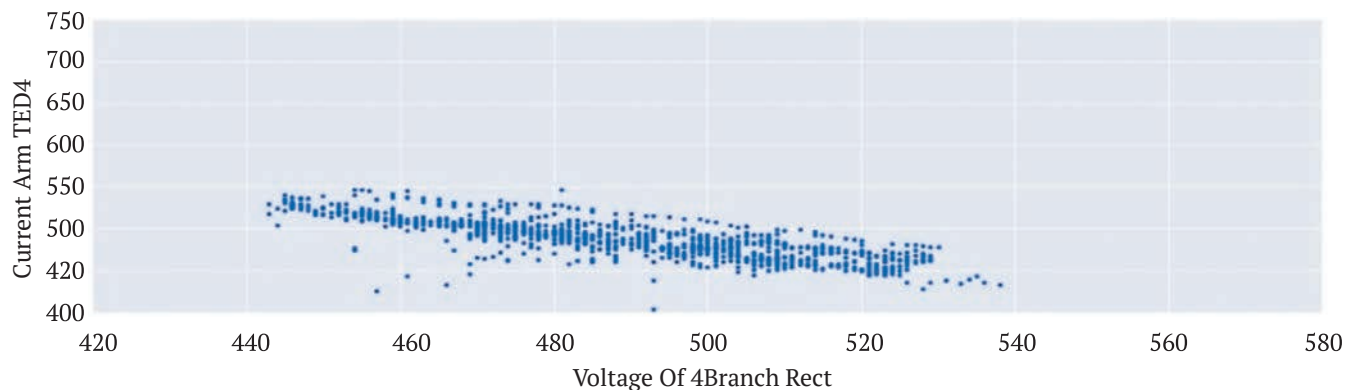

Fig. 7. The relationship between traction motor current and voltage for locomotive 2TE116U #240 unit B on June 6 2017

interrelations and in motor current and voltage interrelations for each ride and for different locomotives. In Figure 3, locomotive unit A, 2TE116U #295, has the same interrelation between traction motor current (Current Arm TED in fig. 3) and voltage (Voltage Rect Of 1 Branch Rect in fig. 3) from September 10, 2014 to January 31, 2015. Meanwhile, for unit B this relationship begins to split in two, which indicates the traction motor's transition to a condition nearing failure⁴. In this case, the motor is still usable but faulty.

An analysis of the traction motor's current and voltage performance shown in Figure 4 indicates that the splitting is related to a motor current. Figure 5 shows a fluctuation in the motor's voltage (Voltage Of Branch 1Rect in fig. 5) to a near permanent value from September to December. In addition, current value (Current Arm TED1 in fig. 5) is

slowly decreasing until December 2014. This indirectly indicates that the problem isn't related to the rectifier but, quite possibly, to the traction motor itself.

For recognizing features that might be related to a problematic method "Insulation for-est" and "Linear regression" were applied.

Studies of the frequency of anomalies and the standard deviation show that for unit B the graphs split in December, 2014. Meanwhile for unit A, this split appears between May and June, 2015. The traction motor current and voltage interrelations are shown in Figure 5, where all deviations of experimental parameters from models are highlighted in red.

This method was subsequently applied to other 2TE116U and 3TE116U DPUs with known repair dates with reference MCU data taken from 2TE116U #295 locomotive (unit A). Comparisons with 2TE116U #132 demonstrat-

⁴ V. Pavlov. 2TE116U DPU. Analytical report. – Kazan: Clover Group LLC, 2017. – 7 p.

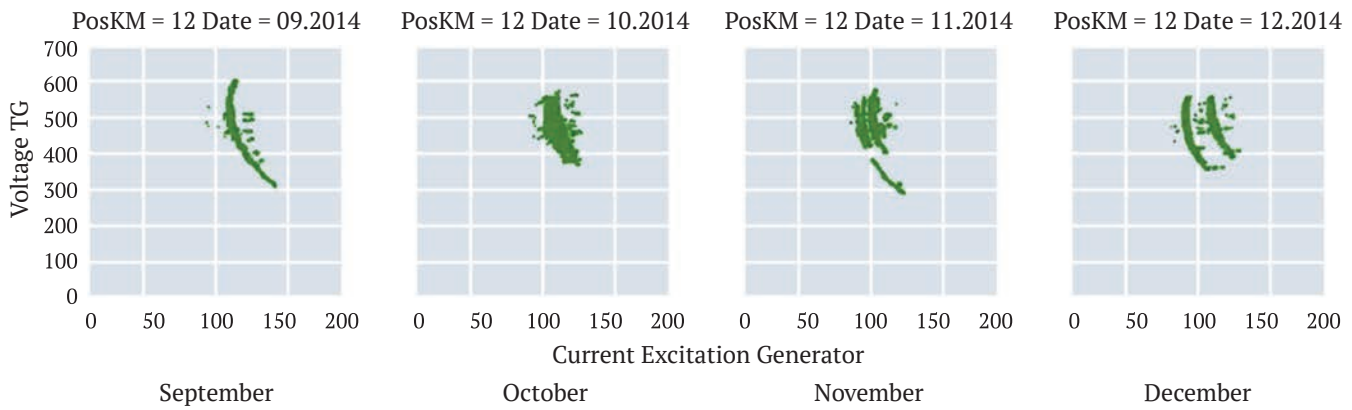

Fig. 8. Variations in the generator voltage to excitation current relationship for locomotive 2TE116U #295 unit A for four months of 2014

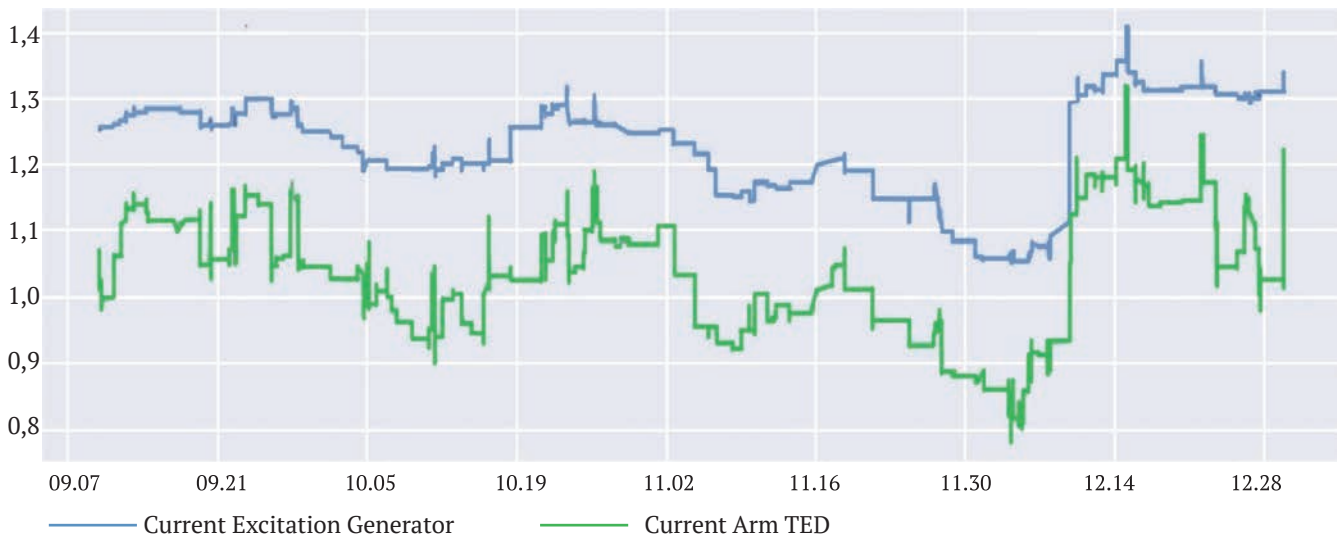

Fig. 9. Variations in generator excitation current and traction motor current for locomotive 2TE116U #295 unit A for four months of 2014

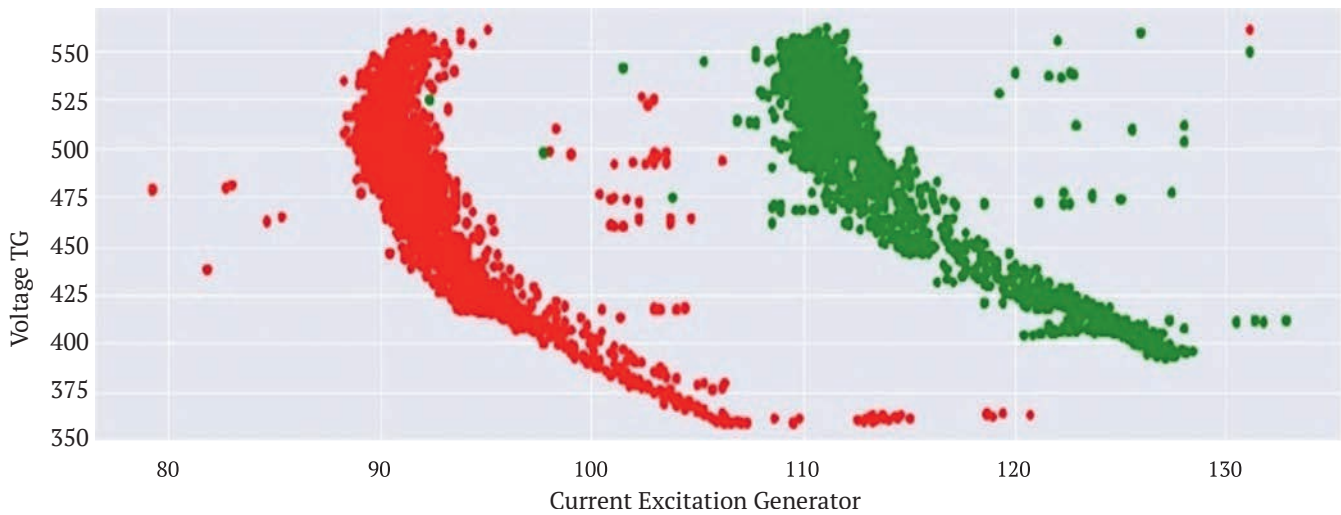

Fig. 10. The relationship between generator voltage and generator excitation current in 12 controller positions

ed that the relationship between motor currents and voltage for different locomotives in different time lines was relevant.

For some locomotives like 2TE116U #248 and 2TE116U #291 splits were found on performance graphs, possibly indicating a near-failure condition. For example, Figure 6 shows unit B of locomotive 2TE116U #240, which has similar a traction motor current (Current Arm TED1) from voltage (Voltage Rect Of Branch 1 Rect) relationship on March 7, 2017. On May

11, 2017 the locomotive required an off-schedule repair due to a traction motor failure.

2TE116U #240 Unit A was repaired on May 22, 2017, and data from June 6, 2017 shows that there is no split in the relationship between motor current and voltage (fig. 7).

Similar results were obtained for the electro-mechanical motor model and led to the conclusion that traction motor current causes a split in the relationship with motor current voltage.

Traction generator operation analysis

With the traction motor to generator voltage relationship study failing to identify any splits, the research was expanded to include similar models for the rectifier, main generator and exciter, and the feedback between these different elements.

This study of a more complex model of locomotive electric transmission found the gradual appearance of a split in traction generator voltage (VoltageTG in fig. 8) and traction generator excitement current (Current Excitation Generator current in fig. 8).

This shows that the generator voltage to generator excitation current relationship splits because of the excitation current.

Let's compare the behavior of traction generator excitation current (Current Excitation Generator in fig. 9) with traction motor current (CurrentArmTED1 in fig. 9). The relationship over a period of time seems to be similar; there is a steady decrease from September to December and abrupt increase on December 10, 2014. Based on a model of the 2TE116U locomotive, it is possible to say that the cause of value decreasing from September to December was the traction generator excitation current, which was followed by a decrease in the traction motor current. The abrupt value change on December 10, 2014 suggests that there could be an excitatory repair, but because official sources do not contain any information about off-schedule repairs of this locomotive during this period, the most realistic explanation is debugging occurring during regular service.

Finally, let's consider the relationship between traction generator current (VoltageTG

in Fig. 10) and excitation current (Current Excitation Generator in Fig. 10) over two separate time intervals. The first ran from December 1 to December 10, 2014 (red dots), while the second ran from December 10 to December 31, 2014 (green dots). Figure 10 shows that the values retrieved under near-failure conditions differ significantly from the values recorded during normal operation.

Further investigations of the route causes of the falls in exciter operation value (model scheme Table 2) did not produce any results during the specified time periods as there were no deviations in parameter variation.

Table 2. Traction generator exciter model scheme

Ingoing parameter	Outgoing parameter
Exciter excitation current	Generator excitation current
Excitation control unit thyristors opening angle	empty
Rheostate testing mode toggle	
Engine shaft rotation frequency	
Exciter excitation contactor lock	
Exciter excitation contactor	
Emergency excitation contactor lock	
Emergency excitation contactor	
Excitation control unit door lock	

Using BigData and machine learning methods to develop models with the data retrieved from locomotive MCUs reveals hidden regularities in DPU equipment operating parameters. This process can identify near-failure conditions for specific units and detect previously hidden cases for off-schedule repairs. (S)

Efficient applications of rechargeable Li-Ion Batteries



Oleg Gur'yashkin
Director General at Sotelkom

A variety of Lithium-ion batteries are now available for a wide-range of uses in different systems and applications. With significant cost-saving benefits on offer compared with traditional lead-acid batteries, use of these batteries is becoming increasingly widespread.

Li-ion batteries in rail application

Lithium Titanate Oxide (lithium titanium oxide (LTO)) batteries (see Pic. 1) are the most efficient battery currently available to power various hybrid vehicle propulsion systems. A low nominal cell voltage of 2.4V, the lowest energy density among li-ion family, is among these batteries' superior characteristics, which also include a rapid charging time of six to 10 minutes and an outstanding lifespan with tens of thousands of charges/discharge cycles possible.



Pic. 1. Li-ion batteries based on lithium titanate technology

Combining lithium iron phosphate batteries (LFP battery) and supercapacitors is an alternative solution for hybrid propulsion systems. This configuration is used in the TEM9H hybrid shunting locomotive. Here, the supercapacitor provide a fast link that can accept and deliver a high-capacity charge over a short period of time. The use of the supercapacitor reduces the current load on the battery during a cold start of the diesel engine or during rapid acceleration. In addition, leveling of the current load may significantly increase the battery's life cycle.

According to Sinara, the manufacturer of the TEM9H locomotive, the hybrid drive and energy storage system configuration provides the following advantages:

- the solution can support operation of all diesel locomotive subsystems for four hours while the locomotive is idle with the engine switched off,
- cold engine start is powered by the supercapacitors,
- diesel fuel consumption is reduced by 30%, and
- emissions are cut by about 55%.

Li-ion batteries have also been successfully applied in catenary-free systems for light rail vehicles (see Pic. 2) which eliminates the need to install unsightly overhead catenary in city centers.

Bombardier's Primove technology is based on the use of a rechargeable battery with a limited capacity of 50kWh and which is recharged at tram stops as well as during the first 20-30m of acceleration.

The battery capacity is sufficient for 40km of operation without charge. However, the LRV is capable of operating for the full day without draining the battery as it is recharged when LRV stops, typically for 45 seconds during passenger service and 10 minutes at terminus stations, and during acceleration when the battery is repowered from the charging circuit. In event of a charging circuit failure or fault, the battery's capacity is sufficient to enable the tram to operate to a terminus station.

Li-ion batteries in industrial automotive applications

Some industrial vehicles use rechargeable batteries as their energy source for movement and operations. A good example is a fork-lift truck, a must-have for every storage site and warehouse.

The critical parameters for a traction battery used for industrial electric vehicles are a combination of the battery's lifespan and price, which defines the cost of a single operating cycle, as well as the charging rate and level of safety. With the present level of technology, the lithium iron phosphate battery, also called LFP battery, is the most appropriate choice for this application (see Pic. 3).

Traction lead-acid batteries are traditionally used in electric fork-lift trucks. However, they have the following disadvantages:

- long charging time of four to 10 hours from when completely discharged to a 100% charge. A fully-charged battery permits fork-lift truck operation during an eight-hour shift. But logistics and warehouse companies that operate double-shifts or 24-hour operation require two or sometimes three batteries for each fork-lift truck. One battery is recharged while another one provides power for the vehicle.
- release of hydrogen and electrolyte vapors during recharging. Maintenance of batteries with compartment covers must be performed in a special charging room, which is cost-intensive to develop, build and operate as it requires a combined extract and input air ventilation system as well as fire-fighting equipment and equipment for leaked electrolyte neutralization according to the requirements of the Cross-sectoral

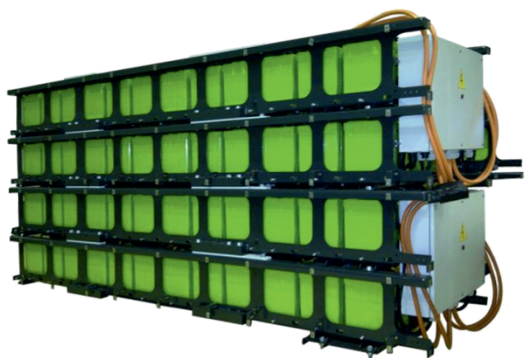

Pic. 3. Lithium-Iron Phosphate Battery



Pic. 2. Catenary-free LRV which uses a li-ion battery

Health & Safety Rules for Industrial Vehicles Operation.

- mandatory maintenance and the need to follow a charge/discharge schedule. Aqueous batteries require regular refilling of distilled water, electrolyte quality and cell voltage checks, and other maintenance operations. Moreover, violation of the charge/discharge schedule causes premature degradation of the battery or potentially a breakdown. As a result, companies with vehicles using acid technology require a special division to maintain the batteries and ensure their proper working order.
- short lifetime. The specified lifetime of the best current-generation acid batteries with liquid electrolyte does not exceed 1,500 charge/discharge cycles. Imperfect operating conditions and operative modes often further diminish battery life.

The acid battery family also includes a battery with an immobilized electrolyte, which is also known as lead-acid gel battery. These batteries do not require special charging facilities and no distilled water refilling. However, they cost around 30-40% more and their lifetime is one-and-a-half times lower than a typical acid battery. A special recharging team is also required for operators of gel-based batteries in vehicles as it is imperative to follow the battery charge/discharge schedule to avoid premature battery degradation.

Advantages of traction LFP batteries

The evolution of li-ion energy storage technology initiated the creation of a new advanced product: the lithium iron phosphate (LiFePO₄) battery. Like other types of lithium-ion batteries, this battery has a high gravimetric energy density of more than 100Wh/kg, or around three-times more than lead-acid batteries.

The competitive advantage of the lithium iron phosphate chemistry over other types of lithium-ion systems is its high fire and explosion resistance due to the electrode materials and electrolytes' chemical properties. This type of battery does not cause a fire or explosion in the event of overcharging, long-term short-circuit, or a breakdown in battery jar mechanics.

In addition, some battery manufacturers offer special design features that prevent current flow through the battery as a result of overheating.

An in-built control and monitoring system serves as an additional protective level in the completed traction battery. This system enables continuous monitoring of voltage and temperature parameters in every battery cell as well as current flow through the battery. Should any of the above parameters be beyond their limit, the system opens a power-circuit limit switch, cutting the battery off from the external circuit.

The higher cost of the li-ion battery is far outweighed by the number of beneficial advantages on offer:

- a reduction in battery maintenance costs. As it is encased within a sealed container, a lithium-ion battery is maintenance-free during its service life of at least five to seven years. Charging is fully automatic due to an embedded control and monitoring

system while plugging the battery in or out for charging is straightforward for a vehicle operator to perform, enabling battery maintenance staff to be reassigned to perform other activities. Traction lithium-ion batteries do not require specially-equipped charging rooms as stipulated under the State Fire Safety Authority regulations. For newly-built facilities the cost of creating special charging rooms are eliminated while at existing facilities the maintenance costs associated with charging rooms may be decreased accordingly.

- offers the possibility to use a single battery even in cases where vehicles operate for 24 hours a day. Li-ion batteries take 1.5 - 2 hours to fully charge. They are also susceptible to memory effects and may easily withstand partial charge and discharge, which allows fast battery charging during downtime. This eliminates the need for extra batteries as a single li-ion battery can replace two acid or gel batteries.
- long lifetime. The designed service life of lithium iron phosphate batteries varies from 3,000 to 5,000 charge/discharge cycles, which results in lower costs per single charge/discharge cycle for li-ion batteries in comparison with acid batteries,
- lower energy consumption and improved energy performance. Any rechargeable battery loses some energy during charging due to thermal losses. However, with a charging efficiency of around 92% compared with 75-80% for acid and gel batteries, lithium iron phosphate batteries have a superior performance.
- li-ion batteries may also be partially charged and discharged, making it possi-

Table 1. Total costs per 2 years of operation, EUR

Type of costs	Lead-acid battery	Li-ion battery
Battery purchase price	7,056	8,625
Charger purchase price	653	1,700
Battery maintenance cost (labor, spare parts & components, consumables)	653 × 2 batteries × 2 years = 2,612	0
Cost of battery recharging energy	1,751	1,268
Total costs during 2 years	12,072	11,593

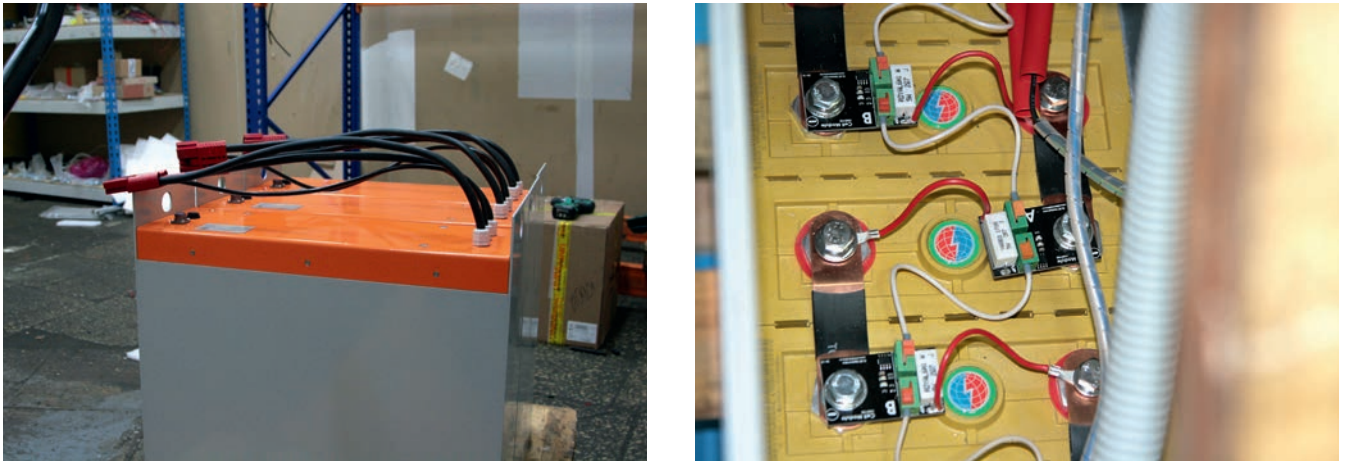

Fig. 4. Lithium-ion drive STK.24.260

ble to recharge the battery during lunch breaks, team changeover intervals, and other idle periods without diminishing

battery life. This means that lower capacity batteries can be used as they will not have a negative effect on the work in progress.

Cost-to-use analysis of traction LFP batteries

The following is a cost comparison of two different types of battery used during a two-year operating period. Calculation assumptions used here are as follows:

- purchase price of a reliable 48V 460 Ah lead-acid battery: 3,528 EUR;
- purchase price of lead-acid battery charger: 653 EUR;
- purchase price of a 48V 300 Ah li-ion battery: 8,625 EUR;
- purchase price of li-ion battery charger: 1,700 EUR;
- maintenance costs, including labor and maintenance operations for a single lead-acid battery: 653 EUR per-year;
- performance factor of a transformer/rectifier type charger used for lead-acid batteries: 80%;
- performance factor of a high-frequency charger used for li-ion batteries: 90%;
- input/output power performance (energy efficiency) of lead-acid batteries: 75%;
- input/output power performance of li-ion batteries: 92%;
- electricity price: 7 eurocents per kWh.

The total cost of energy consumed during two years of operations was estimated based on the assumption of one full charge/discharge cycle per day with due consideration to the electricity lost as heat both in the charger and battery.

Lead-acid battery capacity is estimated as $48 \times 460 = 22\,080\text{Wh}$ i.e. 22.1kWh. With due regard to the battery and charger output-input ratio, one charge cycle will require $22.1 / (0.8 \times 0.75) = 36.8\text{kWh}$ of supplied energy. Based on the electricity price of 7 eurocents / kWh gives us $36.8 \times 7 \times 365 \times 2 = 1,880.5$ EUR for a two-year period.

With a stronger performance factor, the li-ion battery and its charger will require a lower volume of consumed energy to perform the same amount of transport operations. The difference can be estimated through a correlation of the performance factor, and is $(0.75 \times 0.80) / (0.90 \times 0.92) = 0.725$. Thus, the energy costs for li-ion battery for a period of two years will be $1,880.5 \times 0.725 = 1,363.36$ EUR.

The above demonstrates that the payback of a transition to li-ion batteries will take no more than three years, and in high utilization cases, could be reduced to less than two years.

Using a li-ion battery during the specified lifetime of at least five years may result in more than 6,534 EUR in savings. With thousands of electric fork-lift trucks in under operation at Russian Railways' (RZD) and other sector-related companies facilities, switching to li-ion batteries has the potential to save hundreds of millions rubles per year. (€)

A practical application of RAMS studies for brake systems

Sergey Chuev

Dr., Honored Designer at Russia, General Designer of MTZ TRANSMASH

Nikita Borisov

Head of the RAMS Studies Team at MTZ TRANSMASH

Sergey Timkov

Dr., Deputy General Designer for Technical Safety and Certification at MTZ TRANSMASH

The introduction of International Railway Industry Standards (IRIS) (ISO/TS 22163) at Russian railway industry suppliers has sparked enhanced studies into areas such as product reliability, availability, maintainability and safety management, including products' lifecycle cost management (RAMS/LCC), project management, and configuration management. In particular, significant work has been carried out regarding the implementation of RAMS/LCC. This includes the development of the regulatory base, reorganisation of activities, and employee development, including through participation in foreign workshops and greater willingness to share experience.

Topicality of the question of formation and confirmation of RAMS indicators

The International Railway Industry Standard (IRIS), which was integrated into the scope of ISO [1], namely section 7.11 «Reliability, availability, maintainability and safety/life cycle cost (RAMS/LCC),» [2] establishes requirements for railway enterprises covering certain aspects of RAMS activities, including:

- calculations and documentation;
- data collection, analysis and a plan of improvement activities, and
- fulfilment of set tasks in accordance with the plan of activities.

The main targets of MTZ TRANSMASH JSC as a manufacturer of brake systems, which guarantee the safety of railway traffic participants, with regard to the RAMS are:

- identification of the design and technological deficiencies of a product which reduce its reliability as well as weaknesses in the organisation of maintenance, repair and operational activities;
- improvement of products' design, the manufacturing process, rules and standards of maintenance, repair and operation;
- checking conformity of the product's reliability with established requirements by verifying RAMS indicators;
- refinement of failure criteria and the limit condition of products;

- taking corrective and preventative actions in the event of non-conformities with RAMS to the extent that this prevents the same problems from reoccurring in the future, and

- an assessment of the effectiveness of measures to improve reliability.

Solving the above tasks makes it possible to achieve a key objective: improving the quality, reliability and consumer properties of manufactured products. Each series of studies is required immediately and this need will continue infinitely. However, there are which require special attention.

The ASTO brake equipment manufacturers and consumers association, with the support of NP UIRE, developed a document entitled, «Regulation on monitoring the quality of maintenance, repair and operation of railway rolling stock brake equipment.» With the reliability of products passing scheduled repairs deemed unsatisfactory, the document outlines targets to improve the reliability of brake systems and therefore enhance railway transport safety.

Obtaining data from the manufacturers regarding the operational performance of products is an important part of this process and indispensable to fulfilling the requirements of IRIS standard (ISO/TS 22163) for management and confirmation of RAMS and LCC indicators.

Organising activities for collection, analysis and confirmation of RAMS/LCC indicators

Achieving these targets is based on the fulfilment of the following tasks:

1. The supply of complete, reliable, continuous and timely information on failures of products and components to manufacturers of railway equipment and machinery
2. Recording, processing, and classification of the gathered information and subsequent analysis of the areas of interest using statistical methods.
3. Development and implementation of technical requirements such as the design process and organisational measures by a cross-discipline team. On the manufacturing site this team will include members of the Reliability Department (RD), Technical Control Department (TCD), Special Brake Building Design Bureau (SBBDB), Chief Technologist's Department (CTD), and manufacturing shops, or, if applicable, a manufacturer's established quality commission. Ancillary equipment suppliers and expert organisations may also be involved in this process.
4. Analysis of the processed operational information on the effectiveness of the measures implemented to improve the quality, reliability and safety of brake equipment products.

In addition, the process will involve analysis of the approaches taken to ensure the brake equipment's quality, reliability and safety management. We believe that this activity should be based on the following principal stages [4]:

- observation planning;
- carrying out observations, monitoring;
- collection of operational data on the products' reliability;
- record-keeping and documentation of operational data;
- processing a wide range of information;

- analysis of a wide range of information;
- calculation of reliability and safety indicators;
- verification of reliability indicators;
- development of corrective and preventive measures, and
- assessment of the effectiveness of implementation of these corrective and preventive measures.

Planning the frequency of observations depends on the specific task and excludes information lost from tolerance probability. For the purpose of developing a common approach for observation programmes, the basic requirements for the content of these activities should be determined. The following information is recommended for inclusion:

- targets and tasks of information collection;
- list of observed products;
- number of products;
- duration of observations;
- terms of indicators on which information is collected;
- establishment of clear examination intervals;
- timelines for the performance of specific works;
- number and location of information collection points;
- requirements for information collection and processing methods;
- interval and reporting forms, and
- a list of enterprises and organizations from which information is received and to which collected and processed data should be sent.

The next stage, from the viewpoint of chronology, defines specifically the requirements and parameters for constant, periodic and one-time observations of brake equipment while in operation.

RAMS tasks in the information field

The active development and engagement of information systems for collection, record-keeping and analysis of operational information to support tasks to improve the

quality and reliability of railway rolling stock systems is one of priorities of this work. Methods to collect data and record automation, which exclude the human factor together with

mented and applied at the enterprise and is regulated by instruction No. 11-05: «Collection and processing of information on products' reliability in operation».

For the purpose of creating an efficient information collection system that ensures the quality, reliability and safety of the manufactured equipment, we will identify the following sources of primary information:

1. Results of investigations into failures, which are in accordance with the requirements of STO RZD 1.05.007 "Claim management: general procedure", which establishes the procedure of contacting a supplier or contractor; the rules of preparation and record-keeping for claim documents (claim report, study report, technical means refurbishment certificate) and their standard forms; and the procedure for refurbishing or replacing defective goods and for identifying the reasons that defects have occurred. This will provide weight to claims of the goods' quality and completeness.
2. Information on scheduled maintenance and scheduled repairs.
3. Information on service hours from the start of operation and following the performance of scheduled repairs.
4. Name plate data for products mounted on rolling stock.
5. Conformity with operating conditions and nominal ratings.

When developing the requirements for a modern information system, a number of significant functions must be guaranteed:

- Identification of unserviceable equipment, failure types and the reasons for failure. This will involve tracking the dynamics and quantity of any changes that take place in absolute values but also in respect of a unit of rolling stock or respective service hours, or kilometres travelled.
- An efficient system of communication between design and engineering departments, manufacturing departments and organisations as well as operations and repair providers for the purpose of the prompt troubleshooting, which will help to improve the quality, reliability and safety of railway transport products. It is recommended that research and expert

organisations engage in the data exchange process and solution development system, if necessary.

- Calculation, formation and confirmation of the quantitative RAMS indicators in accordance with the established nomenclature, including checking whether the achieved level of reliability meets established requirements.
- A comprehensive and objective study of the reasons for the occurrence of failures and the processes under which rolling stock service is interrupted, including deviations from rated values, outward appearances, and the consequences of failures.
- An accurate assessment of the expected life of manufactured equipment under existing operating conditions. This is particularly topical for products with a cyclic function such as brake equipment.
- A cross-discipline analysis of the effectiveness of implementing measures that will eliminate or reduce the rate of failure or problems with certain products, including measures that will eliminate the reoccurrence of certain failures.

At present, developers rely largely on written notifications, telegrams and claims detailing the facts of individual technical equipment failures. Based on this, an analysis of the completeness and reliability of this information was carried out with the information refined and expanded as necessary. The result of the decisions made might include on-site visits by qualified specialists or the return of the product for further study.

Operational data collection and tracking is directly accompanied by processing of received data as it is determined by such priority aims as consolidation, structuring and data truthfulness and completeness control.

The structure of activities for processing of information includes:

- classification and codification of input data;
- control of the completeness, reliability and homogeneity of information;
- adjustment of input data (if necessary);
- transfer of input data into the enterprise's information field;
- assessment of reliability indicators;

- classification and analysis of the causes of failure and limited conditions by types associated with manufacture, repair and operation, and
- the preparation of input data to develop measures aimed at identifying deficiencies in performance and improving the products' reliability in operation.

In the course of analysing the reasons for failure and the restricted operation of braking equipment, it is essential to systematically process this information by identifying key attributes such as operating conditions, and service hours. This process provides the opportunity to make an objective assessment of the effectiveness of design and process and (or) organisational measures, and to identify cases of violating the terms and requirements of operational documentation. It can also support development of a plan of recommendations to eliminate any identified deficiencies.

Based on the results of the operational information analysis, calculation of brake equipment reliability and safety indicators, it is possible to conduct a verification and rating process of the reliability indicators according to specific technical specifications. Fulfilment of these set tasks is conducted in accordance with RD 50-690-89 «Methodology guidelines for industrial product reliability: Methods of assessment of reliability indicators, using experimental data» [5].

These analyses and calculations clearly show that deficiencies do exist. For the purpose of their elimination, uniform provisions

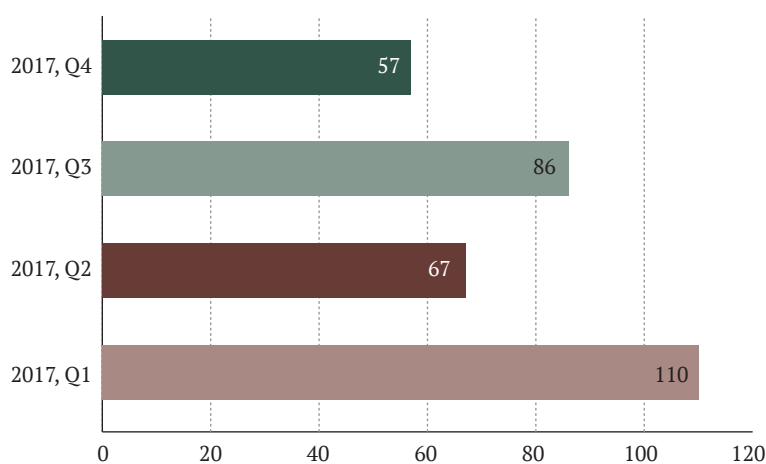

Fig. 2. Change in the number of attributed failures in the KASANT data management system

that calculate and confirm RAMS indicators should therefore be developed consistent with the goal of eliminating these problems currently GOST 27.301-95 «Industrial product reliability calculation: basic provisions» does not reveal the source of the problems. [6] Critically, this work will provide a uniform process for calculating and submitting results of respective studies, which will provide a greater opportunity for reproduction and review and the development of a universal assessment method. Indeed, these measures will help to end disagreements between interested parties which currently use different methodologies for assessments when comparing RAMS indicators.

It is common practice to carry out a mandatory assessment of the effectiveness of implementing corrective and preventive measures. If negative assessments of the efficiency of the chosen measures are received, the failure management procedure is restarted until a positive effect is gained.

Thus, as a result of implementing the RAMS study tools at the enterprise, a system approach to assessing the quality, reliability and safety management of manufactured products has been developed. Key factors adversely affecting the operation of braking equipment during operation and after-sales maintenance stages have been identified. This knowledge has made it possible to focus the efforts of specialists on problem points and to improve the management of these incidents when they occur.

This process of enhancing product lifecycle management may provide benefits beyond the enterprise. For example, by offering a quantitative assessment and ultimately reducing locomotive failures and improving reliability, it is possible for manufacturers to extend warranty periods and turnaround intervals for newly-developed brake equipment.

In addition, data retrieved from the automated KASANT complex recording system, which helps to analyse performance and control and eliminate the technical causes of failure may be considered as objective evidence of the results of implementing a RAMS management processes.

Let's consider the example of brake equipment mounted on freight railway rolling

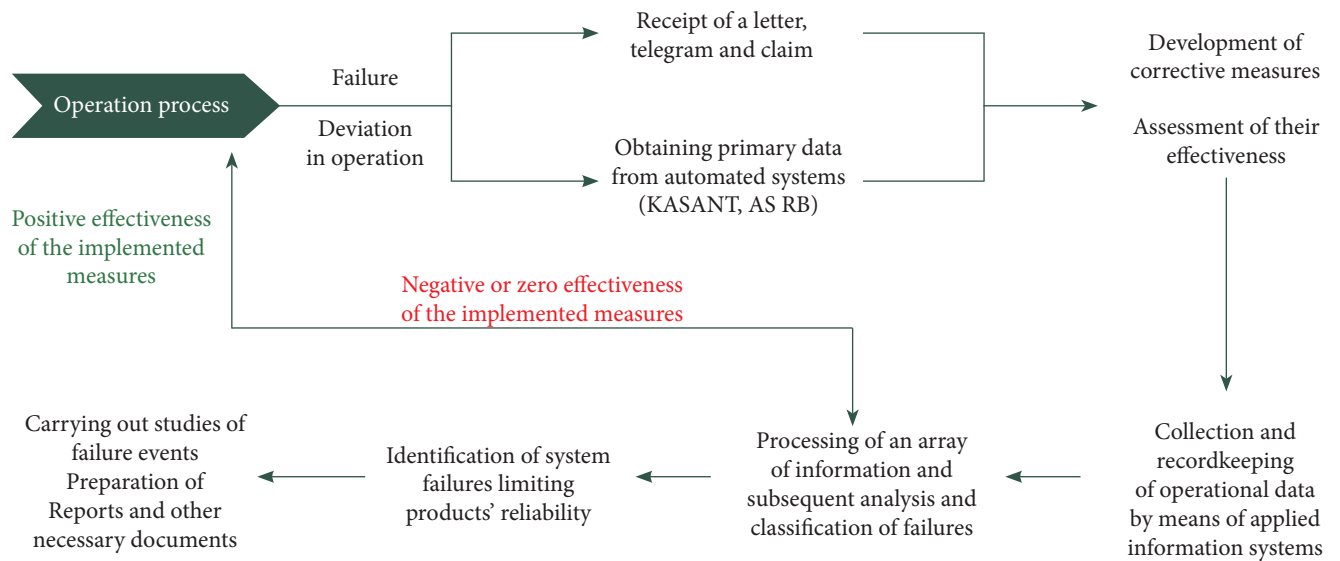

Fig. 3. Information collection architecture

stock. Figure 2 shows the positive dynamics of a change in the number of attributed failures when using the KASANT automated system.

The same positive trend is observed in the locomotive complex. Based on the results of verification over past reporting periods, the performance of key reliability indicators (failure flow parameter) as rated in the technical specifications, was identified for the brake

system used on 2ES6 twin-unit DC electric freight locomotives, 2TE25KM freight twin-unit diesel locomotives, and 2TE25A Vityaz metro train. According to the distribution of autobrake equipment failures on the warranty-covered 2TE25A diesel locomotives for 12 months in 2016-2017, failures were reduced by 44%.

The concept of brake equipment quality, reliability and safety information flows

The structure and order of information flows are based on the principles of cyclic management (fig. 3).

Throughout warranty and post-warranty operation, observations of brake component performance rely on receipt of claims, telegrams and notifications as well as data from information automation systems such as KASANT and AS RB. Studies by highly-qualified employees to identify the reasons for failures make it possible to obtain objective information on the root causes of these problems. Test efficiency is ensured by creating a single information space at the enterprise with access enabled according to the areas of responsibility of respective departments.

The distribution of information flows are built depending on the stage of the product's life cycle (fig. 4).

The concept is developed during the pre-project stage. Here technical solutions are defined and trialled with the process relying on information regarding the reliability and safety of the functional systems under consideration, which can include both new concepts and those already proven to work well on rolling stock. As the technical assignment is developed and approved, target values for the technical characteristics of the specific object that is being designed are also defined at this early stage.

Information regarding operating conditions and prospective loading modes are taken from a single database of information supporting the correct and efficient planning of control tests on test-bench equipment. Establishing a testing procedure based on substantiation of operation requirements is particularly

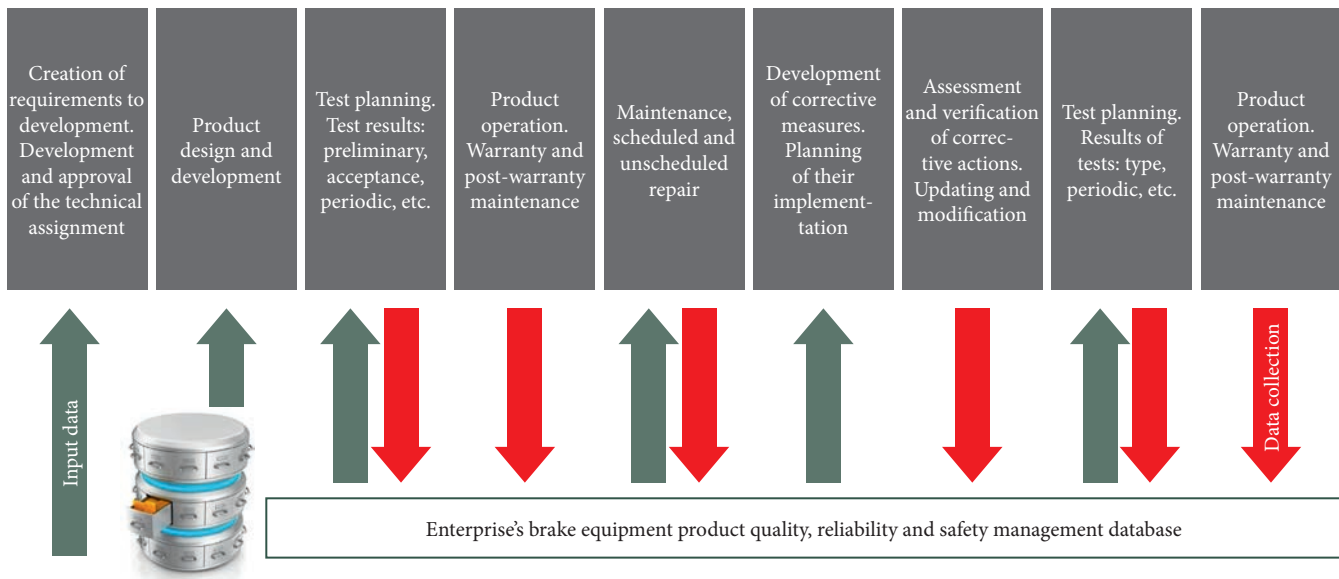

Fig. 4. RAMS data at life cycle stages

important for products which rely on cyclic loading. Verifying reliability and safety indicators during tests to confirm the performance of new components and systems developed from research and development activities in conditions as close to operation as possible makes it possible to minimise the expenditure of both material and labour resources at later stages of the process.

Formalised records of the results of tests ranging from preliminary to acceptance and periodical are fixed within the single database, where they are processed and analysed. Subsequent, data obtained from bench tests is compared with actual operating indicators. Based on the results of this comparative analysis, the testing methods may be adjusted.

Warranty and post-warranty operation provides the manufacturer with an opportunity to acquire a full and objective picture of the quality, reliability and safety of the manufactured product. However, several other factors should be taken into account: quality and the timeliness of maintenance; the impact of scheduled and unscheduled rolling stock repairs on a product's performance; and, of course, conformity with established operating conditions. The effectiveness of communication by the developer with parties responsible for operations and repair is the primary factor that can improve the scheduled preventive maintenance and repair sys-

tem. Statistical data is available that can help one judge the degree of impact of these factors on the performance of railway transport facilities.

Using the adopted database management system and established procedures, important data relating to each failure is recorded, and processing is initiated. Required corrective actions are jointly determined, which may include tracking the development and implementation process and identifying the results of corrective actions plan aimed at reducing the probability of, or eliminating, a failure. At the same time, an information flow is formed regarding the assessment and control of these corrective measures.

Making changes to the basic configuration of products is followed by the actions required to plan and carry out tests while recording and analysing the obtained results which will inform implementation decisions. The quality, reliability and safety management processes follow at a random frequency up to the point where the components are removed from operation and disposed. The database of information regarding the performance of these products and components will inform subsequent projects.

Finally, the approach described here, which provides greater quality and reliability of manufacturer components, will make it possible to move toward digital control of railway systems. (S)

Russian Railways at 15: state railway leads manufacturing development

Russian Railways' (RZD) performance since it was established 15 years ago has shown that the decision to create a single company to act as the customer for both locomotive and passenger rolling stock, and thereby support Russia's leading rolling stock manufacturers, was warranted. A number of key objectives have been successfully achieved, including the introduction of innovative technologies and large-scale upgrades to production capacity.

In 2001, the Russian government adopted the Railway Structural Reform Programme. The Programme's objectives were defined by the pressing need to renew the country's rolling stock fleet, much of which had become outdated and obsolete due to insufficient investment over the previous decade. The programme also sought to improve the reliability of railway transport, and the quality of services available.

While the procurement of freight wagons became the responsibility of private operators, RZD purchased new locomotives, EMUs, DMUs, passenger coaches, track vehicles and machines. Shortly after its establishment in 2003, RZD accepted the new requirements for rolling stock, which it hoped would translate into major improvements in vehicle performance and the introduction of innovative technologies. The objectives for improved performance were reflected in the state's transport development strategy, while its transport machine building strategy also placed an emphasis on developing new rolling stock.

However, the time lost before the launch of these major initiatives deprived Russia's railway industry of the opportunity to thoughtfully and systematically introduce new technologies using its own resources. Moreover, the state's emphasis on accelerating economic growth over a relatively short period left the sector with insufficient time to conduct a full-scale development and testing process for new equipment. To achieve these challenging objectives stakeholders therefore chose to follow another path: establishing joint venture companies with global technology leaders.

With RZD a major prospective customer, Russia's railway market potential was among the most promising in the world and, of course,



Oleg Belozеров, Director General of Russian Railways (RZD) at Bryansk Engineering Plant, June 26, 2018

caught the attention of some of the leading international suppliers, which had tried but failed to enter the Russian market since the 1990s. As a result, under the tight control of RZD, two major partnerships between Transmashholding and Alstom, and Sinara Group and Siemens, which have since defined the image of modern Russian railway sector, were established in the mid-2000s.

Another important focus for RZD was supervising compliance with its requirements during the technology transfer process and coordinating the manufacturers' efforts. These efforts were overseen by the Railway Equipment Industries Union (UIRE), which was founded through the sponsorship of RZD in 2007. UIRE's members include system integrators and component manufacturers, and the body acts as a forum for communication between RZD and rolling stock manufacturers. In addition, the union has served as a platform to launch key initiatives designed

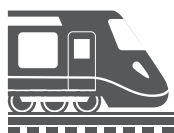

More than **35** new types
of rolling stock have been introduced
since 2004



RZD's annual orders for new
locomotives, passenger coaches and
EMUs support

17,000
high-tech jobs



Russia's locomotive fleet obsolescence
rate decreased from

85%
to 67% between 2003 and 2017

to enhance the sector's competitiveness, including by adopting universal technical regulations, introducing quality management systems at manufacturing sites, and procuring rolling stock based on life cycle cost parameters. These UIRE-supported initiatives have made it much easier for manufacturers to introduce advanced business and production principles, which are vital for the current and future development of rolling stock manufacturing.

unable to enter the Russian market, while advanced domestic solutions, such as gas turbine equipment, had no operational history and thus could not arouse the interest of the newly-formed power generating companies. The only power industry sector showing growth and bringing some revitalising effect to the economy was nuclear power engineering, fuelled by Rosatom, which specified common technical requirements and placed significant equipment orders like RZD has done in the railway sector.



Electric train Sm6 Allegro

Source: press-service of RZD

There are some precedents from other industries that rail has fortunately been able to avoid, including in the power sector. In 2008, RAO UES possessed several generating assets which the national economy urgently required to meet demand for additional energy capacity. However, disparate interests and the lack of a common technical policy brought the power plant engineering industry, which like the rail sector had suffered throughout the 1990s, to a critical juncture. International players, which could offer more efficient equipment had no technology transfer commitments, so were

Over the past decade, Russian rolling stock manufacturers have managed to launch the production of advanced products while building the foundations for localised manufacturing by acquiring design and engineering expertise. The integration of new approaches and international best practice has resulted in the almost immediate introduction of upgraded and modernised rolling stock. This includes the ES5K and 2ES6 electric locomotives, TEP70BS, 2TE25, and TEM18 diesel locomotives, double-deck passenger coaches, and variable-gauge passenger coaches. The sector has also witnessed the accelerated development of brand new rolling stock solutions such as the powerful LNG-operated gas-turbine locomotive, GT1H, which possesses unique traction performance compared with anything available in the global market.

The contracts awarded by RZD for EP20 and 2ES10 locomotives featuring asynchronous traction motors, and Lastochka EMUs (Desiro RUS), were landmark events both in terms of the new rolling stock's technology and performance, and the scale of these orders. At the time of writing, more than 280 locomotives have been delivered to RZD, while it had also received 170 new EMUs. The contracts saw the successful adaption of international solutions



EP 20 electric locomotive with passenger train

adapted to Russian conditions, the transfer of technology for numerous components, and the introduction of solutions designed in-house.

In the areas where localisation is not applicable, RZD has encouraged technological development by other means. For instance, a major adaptation of the Siemens Velaro trains to Russian requirements was carried out before the launch of the Sapsan high-speed service between Moscow and St Petersburg. Substantial design changes and the integration of new components resulted in the development of what was essentially a new train, Velaro RUS. A similar approach was taken during the adaptation and modification of the Sm6 Allegro and Talgo 250 Strizh trains. Under RZD's supervision, all unique solutions were patented and are now the intellectual property of Russian manufacturers, and engineering and R&D centres.

Of course, introducing new technologies has not always been a smooth process over the last 15 years. For example, it has taken time to carry out additional fine tuning and overcome teething problems with certain equipment. Some projects have even failed to reach the mass production stage. For example, the development of some track maintenance vehicles was held back due to insufficient orders.

However, the lessons learned are helping to avoid similar mistakes in the future.

RZD's role in preserving and encouraging development in the high-tech vehicle manufacturing sector is impressive. Between 2003 and 2018, more than 66,000 locomotives, 4,500 passenger coaches and 8,400 EMU and DMU cars entered operation in Russia with RZD's contribution to national economic performance clearly visible; rolling stock orders amounted to an average of 0.1% of GDP per year, and reached 0.2% in 2009 at the height of the economic crisis. RZD's fleet orders also supported an average of 17,000 high-tech jobs each year, while taxes accrued from RZD rolling stock amounted to more than Roubles 200bn between 2003 and 2017.

In comparison with industrial sectors that have followed a different path, the railway sector's experience shows that in the context of a period of economic recovery and tight deadlines for modernisation, the best way to advance is to maximise order consolidation and to build synergies. Indeed, 15 years of any company's history is a significant period of time which should be thoroughly analysed. This issue of Railway Equipment Journal will therefore dig deeper into this topic and provide further detail to readers.

UIRE – bringing together Russia railway manufacturers

In the entire course of history, 11 years is a very short space of time. However, at an institution where all industrial representatives are working together toward specific and shared objectives, a great deal can and has been accomplished in this period. The non-profit Partnership Union of Railway Equipment Industries (UIRE) was established on June 14th 2007 by Russian Railways (RZD), Transmashholding, Concern Tractor Plants and Russian Corporation of Transport Machine Building. The founder and president of the organisation is Valentin Gapanovich. The partnership now consists of 156 member companies from the 34 federal states of the Russian Federation. Together the member companies are responsible for almost 90% of Russia's total railway industrial output.

The UIRE brand is recognisable not only in Russia, but internationally. This is primarily because we successfully coordinate rolling stock manufacturing and consumer activities at a system-level both in the domestic Russia market and Eurasian economic Union, too. We have not only managed to keep the Russian rolling stock building industry from collapsing in the face of significant challenges but have also focused market players' efforts on adopting an innovative approach to sector development. We have good experience in self-organization, promoting effective cooperation, and business activities with successful results in a challenging environment that is sensitive to market fluctuations and often defined by small-batch, low margin orders. Rail vehicle manufacturing dictates to a large extent the technical level and development of Russia's railway, which is the backbone of the national economy. Over the past 11 years, Russia's railways have undergone a technical transformation and are now compliant with, and in some instances even surpass, international standards. This modernisation is the direct result of a recovery in the rolling stock manufacturing industry, which was made possible through the efficient coordination and concerted efforts of the Partnership's team.

UIRE is structured to offer members opportunities to actively participate in existing and to form new committees, sub-committees and sections. Members direct the organisation's activities and can freely address any urgent and pressing issues during the current structural transformation period. This well-developed system, where manufacturers and operators have the chance to participate in the organisation's dialogue, provides sufficient resources to support an effective decision-making process, which is

able to deliver real results. Leading industry representatives and experts now make-up and chair 12 committees, which cover various domains. More than 500 committee, sub-committee, and section council sessions have been conducted so far, with around 12,000 experts representing executive staff and design, engineering and process engineers from various manufacturing plants taking part. At our meetings, international and regional conferences, workshops and round tables we discuss the general course of the Partnership's development, while the relevant committees address highly technical issues.

Our Partnership has created an Inspection Center for the 'Acceptance of Cars and Components,' which is responsible for inspection and acceptance of the rail products that will be delivered to customers. The Center's inspectors identify counterfeit and potentially unsafe products and prevent their use on rail infrastructure. This is a very important and essential structure which is employing highly skilled people.

All UIRE activities run in parallel with the development of a new national technical regulation system. Members are involved with drafting, discussing and implementing a new generation of technical regulations and standards as well as their deployment in the Customs Union and the Eurasian Economic Union. This is a key priority for our work and we have managed to accomplish our major objective: to organise the development of new regulatory documents with companies actively contributing to this process. These actions have created the space for greater industry efficiency in a new economic environment.

Since its creation 11 years ago, the Partnership, with the cooperation of the Institute of



Signing of agreement between NP UIRE and SwissRail at EXPO 1520, 3 September, 2015. From left to right: Michaela Stockli, Executive Director of SwissRail, Peter Jenelten, Vice-President of SwissRail, Valentin Gapanovich, President of NP UIRE, Nikolay Lysenko, Executive Director of NP UIRE

Natural Monopoly Research, has been publishing Railway Equipment Journal. In 2010, the Higher Attestation Commission of the Russian Ministry of Education & Science included Railway Equipment in its peer-reviewed scientific journals. Today the journal serves as a leading platform for the publication of railway-related research and scientific and design achievements in rolling stock engineering. Our writers represent UIRE member companies and share the findings and results of their work on the pages of our magazine. And there is no doubt that the magazine is all about these people, their passion and commitment! Without them the Partnership would not have made such significant progress and gained its current status and reputation. Sometimes it is difficult to achieve agreement on the topics discussed, but according to Socrates, truth can spark when opposing ideas collide.

Throughout its history, UIRE has built partnerships and relationships with friendly associations headquartered in Russia and abroad. Since 2007 we have established business contacts with the European Railway Industry Association (UNIFE.) UNIFE's Presiding Board is chaired by Sabrina Soussan, CEO of Siemens Mobility, and its director general is Philippe Citroën. The Memorandum of Cooperation and License Agreement signed on November 26 2007 became the first step towards cooperation and was followed in 2014 with the signing of a Cooperation Agreement which targets further development of UIRE and UNIFE's shared work to strengthen and support the Russian and European rail vehicle manufacturing sector.

The agreement also facilitates efforts to develop rail transport and is promoting the

adoption of International Railway Industry Standards in Russia, harmonisation of technical regulations and standards related to rail transport, deployment of innovative solutions across the member companies of both associations, and the exchange of information. As a result of successful Russian participation in the IRIS Advisory Board, the International Railway Industry Standards have been translated into the Russian language.

More than 10 cooperation papers have been published as a result of UIRE's relationships with foreign associations and unions, including the Association of American Railroads (AAR), the Association of the Czech Railway Industry (ACRI), the German Railway Industry Association (VDB), SWISSRAIL Industry Association (SWISSRAIL), the French Railway Industries Association (FIF), and the Austrian Railway Industry Association. More than 20 travelling workshops arranged by the Partnership have helped Russian engineers to learn best practice and expertise from the international rolling stock building industry. Exchanges of best practice at conferences, workshops, and in working groups as well as the development of global approaches to research and the compilation of shared technical glossaries has strengthened scientific and technical cooperation.

I would like to particularly emphasise the exceptionally good partnership between SWISSRAIL and UIRE. The Cooperation Roadmap 2020 agreed and signed with the association is a good basis for concrete action. Long-standing relations with VDB are also highly valued. Meetings between our teams at InnoTrans have become a good tradition. 🇨🇭

Contents of Railway Equipment previous issues

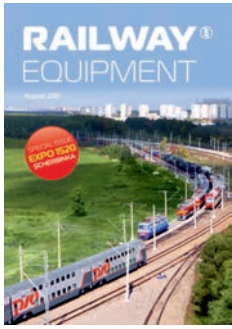

Expo 1520 2017

- **V. Savchuk, I. Skok, A. Polikarpov.** Mixed fortunes for Russian rolling stock manufacturers in 2016
- **A. Savin.** Findings of slab track system trials
- **I. Lakin, I. Pustovoy.** New service agreements enhance locomotive service and repair efficiency
- **Y. Saakyan, V. Savchuk, S. Olenin.** Technical features of Russian high-speed passenger trains
- Statistics of Russian Railway Industry
- **J. Harder.** Technology transfer and developing mechanical engineering in transport
- **O. Senkovskiy.** ISO Industry Standard for the Rail Sector
- **E. Rosenberg.** The Moscow Central Ring Railway: a railway of innovative solutions
- **V. Kerpychev, S. Chuev.** How can distributed braking improve freight train performance and reduce delays?
- **A. Galenko.** Application of traction linear motors in various transport systems
- Russian Association of Railway Equipment Industry celebrates its 10th Anniversary
- **A. Savin, E. Matveeva.** Russia's railway Test Loop celebrates its 85th birthday

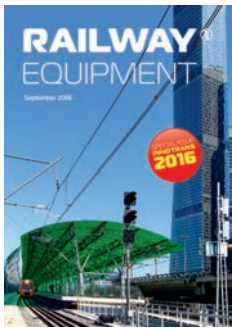

InnoTrans 2016

- **E. Rozenberg.** Processes of Driverless Shunting Operations
- **E. Rozenberg.** URRAN: new model of risk management
- **V. Savchuk, A. Polikarpov, I. Skok.** Russia's railway sector in 2015: the year in review
- **M. Mamonov.** Supporting Russian engineering export
- **V. Kossov.** Gas-turbine locomotive on liquefied natural gas
- **E. Vasyukov.** The world's first gas reciprocating shunter: TEM19
- **S. Orlov.** Technical and design features of the EG2Tv 'Ivolga' EMUs
- **V. Dzyuban.** Underground Cars Refurbishment for Budapest
- **G. Zbov.** Locomotive diesel engines in Russia: current condition and prospects
- **I. Mikhalkin.** Russian innovative technologies
- **V. Kuryanov, M. Sultanov, V. Fokin.** Innovative messenger wire for an overhead contact line system
- **A. Kamyshny, D. Kerentsev, R. Timakov.** Developing and Mastering Wheels for High-Speed EMU "Lastochka"
- **G. Zbov, S. Belov.** Magnetic levitation: an unknown story from Russia

InnoTrans 2014

- **E. Yanchenko, D. Kobelkova.** Developing Olympic-standard transport infrastructure facilities for Sochi
- **A. Stepanov, I. Gurgenedze, A. Cherevan.** Managing and implementing the Sochi Winter Olympics railway timetable
- **B. Kaufmann.** IRIS develops globally
- **S. Gapeev.** Business Management System: Results of Five-Year Deployment
- **M. Nigmatulin, E. Rudakov.** Using IPPEM indices to monitor Russian industry development in the second quarter of 2014
- **A. Polikarpov, A. Slobodyanik.** Russia's railway services market reacts to significant challenges
- **V. Savchuk, I. Skok.** The future of Russian Railway Industry
- **V. Matyushin.** About new railway technical regulation system in the Custom Union
- **O. Nazarov, D. Kiryushin, B. Khomyakov.** The Sapsan high-speed train development and acceptance tests procedures
- **A. Nazarov.** The Experience of launching Sapsan and Allegro highspeed trains in Russia
- **N. Polukhov.** DP-M: A New-Generation Russian DMU
- **M. Lobov.** Applying composite materials in locomotive components
- **A. Dorozhkin, S. Ozerov, M. Aginskih, A. Ushakov, A. Izotov.** Application of Composite Materials in Wagon Manufacturing
- **O. Kravchenko.** Innovative Hybrid Shunting Locomotive
- **D. Tikhonov.** Automatic Driving Systems for Locomotives





InnoTrans 2012

- **V. Gapanovich.** Innovative development of Russian Railways
- **E. Rudakov.** Results of the industrial production condition monitoring based on the indexes of the Institute of Natural Monopolies Research (IPEM)
- 1520 – 1435: prospects for cooperation
- **Y. Saakyan, N. Porokhova.** Russian machinery: State support in crisis and post-crisis periods
- **I. Galiev, V. Nekhaev, V. Nikolaev.** Competitive ability of Russian railways, its connection with dynamic properties of freight car running gear and the ways of their improvement
- **S. F. Podust, S. S. Podust.** Lean production tools effect on efficiency of Novochoerkassk Electric Locomotive Plant LCC (NEVZ)
- **O. Trudov, K. Kostrikin.** Life cycle cost (LCC) methodology application to determine the promising directions of innovative product development
- **V. Kutergin, D. Tarasov.** Peculiarities of price formation for innovative products with account of the ownership cost
- **A. Marchenko, K. Soltus, K. Dorokhin.** Into the future – in the new Russian electric locomotives
- **A. Tishaev, A. Zaycev.** Triple-diesel engine locomotive CME3 ECO: with care about future
- **V. Mironov.** The second floor of efficiency
- **Y. Boronenko, A. Orlova.** Possible ways for unification of freight car bogies, their units and parts at 1520 mm rail gauge
- **Y. Ivanov.** Computer vision technologies for the supervision over objects of railway infrastructure
- **V. Matiushin.** The “unconquerable” heights of quality
- **S. Gapeev.** IRIS standard is the most important component of transformation of Russian railroad industry
- **Y. Babkov, V. Perminov, E. Belova.** Influence of reliability and utilization indexes values on locomotives technical readiness

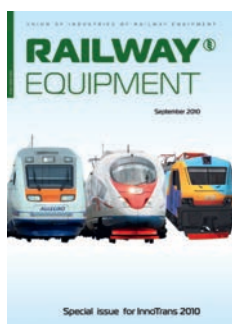

InnoTrans 2010

- **V. Yakunin.** Key problems of railway engineering and possible solutions
- **V. Gapanovich.** JSC “RZD”: Innovation-based development
- **Y. Saakyan.** Effects of the volume and structure of the RZD’s investment program on the situation in railway engineering and related economy sectors
- **K. Kostrikin.** Overview of the preliminary results of railway industry performance in 2009
- **O. Trudov, N. Porokhova, E. Rudakov.** IPEM indices as an alternative approach to online monitoring of the industrial production
- **K. Ivanov.** Innovation in railway engineering development
- **S. Palkin.** Strategic tasks of quality maintenance
- **V. Matyushin, V. Morozov.** Urgent issues of technical regulation in rail transport legislation
- **Y. Saakyan, A. Polygalov.** Development of limit price calculation methodology for rolling stock
- **A. Murashov, N. Ivanova, E. Stavrova.** Life cycle cost (LCC) as a basis for price calculation of railway equipment
- **C. Ponticelli.** Life cycle cost of railway rolling stock: from theory to practice
- **Lifecycle.** Facts and factors
- **V. Matyushin.** Standartization in UIRE: it’s objectives and plans, and their implementation
- **Statistics.** Railway industry in figures
- **V. Zorin.** Development of safety systems and train traffic interval control system based on satellite navigation and digital radio channel to increase the speed and intervals of train traffic
- **V. Rudenko.** Gas turbine locomotive: timely and successful testing
- **S. Usvitsky.** Electric locomotive EP20 - basic platform for new generation electric locomotives

**All articles are available in the Railway Equipment Journal section
at www.ipem.ru**

RAILWAY® EQUIPMENT

FULL REPORTING ON
STATE AND TRENDS OF
RUSSIAN ROLLING STOCK INDUSTRY

INSIDE:

New engineering
solutions in Russia
and outside

Analysis of issues
and opportunities
of railway industry
development

Railway vehicles
manufacturing
statistics

Interviews with
railway sector
decision-makers

Journey into the
history of railways



SUBSCRIPTION OPTIONS

Via all subscription
catalogues of Russia
Subscription number **41560**

Via Online Research
Library **eLibrary.ru**

Via editorial office
directly

Contact details:
Tel.: +7 495 690-14-26
vestnik@ipem.ru



UNITED WAGON COMPANY



DESIGN AND MANUFACTURE FOR ALL CLIENT'S NEEDS AND ALL RAIL GAUGES OF THE WORLD



www.uniwagon.com

WE PRODUCE

World-class freight cars



Castings

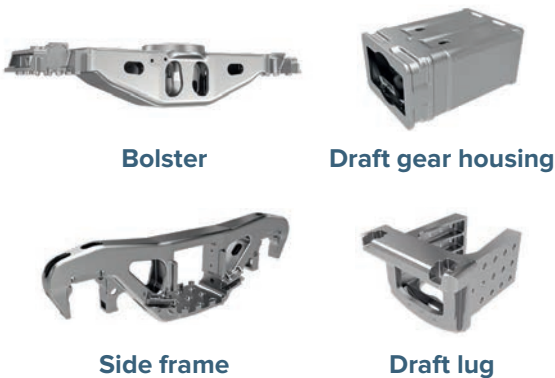

Bolster

Draft gear housing

Side frame

Draft lug

Forging, bending & machining

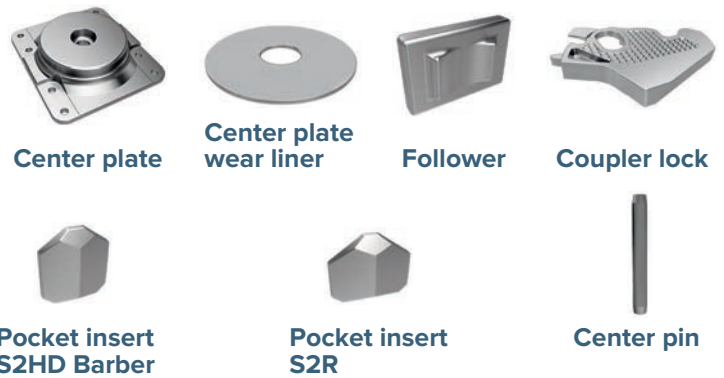

Center plate

Center plate wear liner

Follower

Coupler lock

Pocket insert S2HD Barber

Pocket insert S2R

Center pin

Springs



D-5 spring

S-126-1 spring

Austempered Ductile Iron

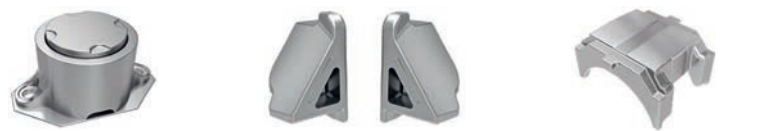

Side bearing

Friction wedges

Bearing adapter



INSTITUTE OF NATURAL MONOPOLIES RESEARCH



RAILWAY INDUSTRY
RAIL TRANSPORT
ENERGY SECTOR

ANALYSIS
STATISTICS
RESEARCH
FORECASTS
REVIEWS



2/7, bld. 1, Malaya Bronnaya st., Moscow, Russia, 123104
Tel.: +7 495 690-14-26
ipem@ipem.ru, www.ipem.ru